

SHARP®

OPERATION MANUAL MODEL PG-M20S



Introduction

Setup and Connections

Basic Operation

Easy to Use Functions

Appendix

DIGITAL MULTIMEDIA PROJECTOR



香港電器安全規格
(國際電工委員會規格適合)

IMPORTANT

For your assistance in reporting the loss or theft of your Projector, please record the Serial Number located on the bottom of the projector and retain this information. Before recycling the packaging, please be sure that you have checked the contents of the carton thoroughly against the list of "Supplied accessories" on page 14.

Model No.: PG-M20S

Serial No.:

This equipment complies with the requirements of Directives 89/336/EEC and 73/23/EEC as amended by 93/68/EEC.

Dieses Gerät entspricht den Anforderungen der EG-Richtlinien 89/336/EWG und 73/23/EWG mit Änderung 93/68/EWG.

Ce matériel répond aux exigences contenues dans les directives 89/336/CEE et 73/23/CEE modifiées par la directive 93/68/CEE.

Dit apparaat voldoet aan de eisen van de richtlijnen 89/336/EEG en 73/23/EEG, gewijzigd door 93/68/EEG.

Dette udstyr overholder kravene i direktiv nr. 89/336/EEC og 73/23/EEC med tillæg nr. 93/68/EEC.

Quest' apparecchio è conforme ai requisiti delle direttive 89/336/EEC e 73/23/EEC, come emendata dalla direttiva 93/68/EEC.

Η εγκατάσταση αυτή ανταποκρίνεται στις απαιτήσεις των οδηγιών της Ευρωπαϊκής Ένωσης 89/336/EOK και 73/23/EOK, όπως οι κανονισμοί αυτοί συμπληρώθηκαν από την οδηγία 93/68/EOK.

Este equipamento obedece às exigências das directivas 89/336/CEE e 73/23/CEE, na sua versão corrigida pela directiva 93/68/CEE.



Este aparato satisface las exigencias de las Directivas 89/336/CEE y 73/23/CEE, modificadas por medio de la 93/68/CEE.

Denna utrustning uppfyller kraven enligt riktlinjerna 89/336/EEC och 73/23/EEC så som kompletteras av 93/68/EEC.

Dette produktet oppfyller betingelsene i direktivene 89/336/EEC og 73/23/EEC i endringen 93/68/EEC.

Tämä laite täyttää direktiivien 89/336/EEC ja 73/23/EEC vaatimukset, joita on muutettu direktiivillä 93/68/EEC.

SPECIAL NOTE FOR USERS IN THE U.K.

The mains lead of this product is fitted with a non-rewireable (moulded) plug incorporating a 10A fuse. Should the fuse need to be replaced, a BSI or ASTA approved BS 1362 fuse marked  or  and of the same rating as above, which is also indicated on the pin face of the plug, must be used.

Always refit the fuse cover after replacing the fuse. Never use the plug without the fuse cover fitted.

In the unlikely event of the socket outlet in your home not being compatible with the plug supplied, cut off the mains plug and fit an appropriate type.

DANGER:

The fuse from the cut-off plug should be removed and the cut-off plug destroyed immediately and disposed of in a safe manner.

Under no circumstances should the cut-off plug be inserted elsewhere into a 10A socket outlet, as a serious electric shock may occur.

To fit an appropriate plug to the mains lead, follow the instructions below:

IMPORTANT:

The wires in the mains lead are coloured in accordance with the following code:

Blue: Neutral

Brown: Live

As the colours of the wires in the mains lead of this product may not correspond with the coloured markings identifying the terminals in your plug, proceed as follows:

- The wire which is coloured blue must be connected to the plug terminal which is marked N or coloured black.
- The wire which is coloured brown must be connected to the plug terminal which is marked L or coloured red.

Ensure that neither the brown nor the blue wire is connected to the earth terminal in your three-pin plug.

Before replacing the plug cover make sure that:

- If the new fitted plug contains a fuse, its value is the same as that removed from the cut-off plug.
- The cord grip is clamped over the sheath of the mains lead, and not simply over the lead wires.

IF YOU HAVE ANY DOUBT, CONSULT A QUALIFIED ELECTRICIAN.

The supplied CD-ROM contains operation instructions in English, German, French, Swedish, Spanish, Italian, Dutch, Portuguese, Chinese (Traditional Chinese and Simplified Chinese), Korean and Arabic. Carefully read through the operation instructions before operating the projector.

Die mitgelieferte CD-ROM enthält Bedienungsanleitungen in Englisch, Deutsch, Französisch, Schwedisch, Spanisch, Italienisch, Niederländisch, Portugiesisch, Chinese (Traditionelles Chinesisch und einfaches Chinesisch), Koreanisch und Arabisch. Bitte lesen Sie die Bedienungsanleitung vor der Verwendung des Projektors sorgfältig durch.

Le CD-ROM fourni contient les instructions de fonctionnement en anglais, allemand, français, suédois, espagnol, italien, néerlandais, portugais, chinois (chinois traditionnel et chinois simplifié), coréen et arabe. Veuillez lire attentivement ces instructions avant de faire fonctionner le projecteur.

Den medföljande CD-ROM-skivan innehåller bruksanvisningar på engelska, tyska, franska, svenska, spanska, italienska, holländska, portugisiska, kinesiska (traditionell kinesiska och förenklad kinesiska), koreanska och arabiska. Läs noga igenom bruksanvisningen innan projektorn tas i bruk.

El CD-ROM suministrado contiene instrucciones de operación en inglés, alemán, francés, sueco, español, italiano, holandés, portugués, chino (chino tradicional y chino simplificado), coreano y árabe. Lea cuidadosamente las instrucciones de operación antes de utilizar el proyector.

Il CD-ROM in dotazione contiene istruzioni per l'uso in inglese, tedesco, francese, svedese, spagnolo, italiano, olandese, portoghese, cinese (cinese tradizionale e cinese semplificato), coreano e arabo. Leggere attentamente le istruzioni per l'uso prima di usare il proiettore.

De meegeleverde CD-ROM bevat handleidingen in het Engels, Duits, Frans, Zweeds, Spaans, Italiaans, Nederlands, Portugees, Chinees (Traditioneel Chinees en Vereenvoudigd Chinees), Koreaans en Arabisch. Lees de handleiding zorgvuldig door voor u de projector in gebruik neemt.

O CD-ROM fornecido contém instruções de operação em Inglês, Alemão, Francês, Sueco, Espanhol, Italiano, Holandês, Português, Chinês, Chinês (Tradicional e Chinês Simplificado), Coreano e Árabe. Leia cuidadosamente todas as instruções de operação antes de operar o projetor.

附送之CD-ROM光碟中，有用英文、德文、法文、瑞典文、西班牙文、意大利文、荷蘭文、葡萄牙文、中文（繁體中文和簡體中文）、韓國文和阿拉伯文所寫的使用說明書。在操作本投影機之前，請務必仔細閱讀整本使用說明書。

附送之CD-ROM光碟中，有用英文、德文、法文、瑞典文、西班牙文、意大利文、荷兰文、葡萄牙文、中文（繁体中文和简体中文）、韩国文和阿拉伯文所写的使用说明书。在操作本投影机之前，请务必仔细阅读整本使用说明书。

제공된 CD-ROM에는 영어, 독일어, 프랑스어, 스웨덴어, 스페인어, 이탈리아어, 덴마크어, 포르투갈어, 중국어(번체자와 간체자), 한국어, 그리고 아랍어로 작성된 조작 설명서가 포함되어 있습니다. 프로젝터를 조작하기 전에 조작 지침을 상세 하게 숙지하십시오.

تتأسطوانة CD-ROM المجهّزة تتضمن تعليمات التشغيل لكل من اللغات الانجليزية، الألمانية، الفرنسية، السويدية، الاسبانية، الإيطالية، الهولندية، الصينية، الصينية القديمة والصين المبسطة)، الكورية، والعربية. قم بقراءة تعليمات التشغيل بعناية قبل تشغيل جهاز العرض الاسقاطي.

Before using the projector, please read this operation manual carefully.

Introduction

ENGLISH

There are two important reasons for prompt warranty registration of your new SHARP Projector, using the REGISTRATION CARD packed with the projector.

1. WARRANTY

This is to assure that you immediately receive the full benefit of the parts, service and labor warranty applicable to your purchase.

2. CONSUMER PRODUCT SAFETY ACT

To ensure that you will promptly receive any safety notification of inspection, modification, or recall that SHARP may be required to give under the 1972 Consumer Product Safety Act, PLEASE READ CAREFULLY THE IMPORTANT "LIMITED WARRANTY" CLAUSE.

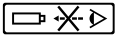

U.S.A. ONLY

WARNING: High brightness light source. Do not stare into the beam of light, or view directly. Be especially careful that children do not stare directly into the beam of light.



WARNING: To reduce the risk of fire or electric shock, do not expose this product to rain or moisture.

See bottom of actual set.

	CAUTION RISK OF ELECTRIC SHOCK. DO NOT REMOVE SCREWS EXCEPT SPECIFIED USER SERVICE SCREWS.	
CAUTION: TO REDUCE THE RISK OF ELECTRIC SHOCK, DO NOT REMOVE COVER. NO USER-SERVICEABLE PARTS EXCEPT LAMP UNIT. REFER SERVICING TO QUALIFIED SERVICE PERSONNEL.		



The lightning flash with arrowhead symbol, within an equilateral triangle, is intended to alert the user to the presence of uninsulated "dangerous voltage" within the product's enclosure that may be of sufficient magnitude to constitute a risk or electric shock to persons.



The exclamation point within a triangle is intended to alert the user to the presence of important operating and maintenance (servicing) instructions in the literature accompanying the product.

WARNING: FCC Regulations state that any unauthorized changes or modifications to this equipment not expressly approved by the manufacturer could void the user's authority to operate this equipment.

U.S.A. ONLY

INFORMATION

This equipment has been tested and found to comply with the limits for a Class A digital device, pursuant to Part 15 of the FCC Rules. These limits are designed to provide reasonable protection against harmful interference when the equipment is operated in a commercial environment. This equipment generates, uses, and can radiate radio frequency energy and, if not installed and used in accordance with the operation manual, may cause harmful interference to radio communications. Operation of this equipment in a residential area is likely to cause harmful interference, in which case the user will be required to correct the interference at his own expense.

U.S.A. ONLY

The enclosed computer cable must be used with the device. The cable is provided to ensure that the device complies with FCC Class A verification.

U.S.A. ONLY

WARNING:

This is a Class A product. In a domestic environment this product may cause radio interference in which case the user may be required to take adequate measures.

WARNING:

The cooling fan in this projector continues to run for about 90 seconds after the projector is turned off. During normal operation, when turning the power off always use the **POWER** button on the projector or on the remote control. Ensure the cooling fan has stopped before disconnecting the power cord.
DURING NORMAL OPERATION, NEVER TURN THE PROJECTOR OFF BY DISCONNECTING THE POWER CORD. FAILURE TO OBSERVE THIS WILL RESULT IN PREMATURE LAMP FAILURE.

PRODUCT DISPOSAL

This projector utilizes tin-lead solder, and a pressurized lamp containing a small amount of mercury. Disposal of these materials may be regulated due to environmental considerations. For disposal or recycling information, please contact your local authorities or, if you are located in the United States of America, the Electronic Industries Alliance: www.eiae.org.

Caution Concerning the Lamp Replacement

See "Replacing the Lamp" on page [71](#).

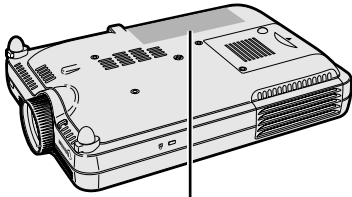

LAMP REPLACEMENT CAUTION

BEFORE REMOVING THE SCREW, DISCONNECT POWER CORD.
HOT SURFACE INSIDE. ALLOW 1 HOUR TO COOL BEFORE REPLACING THE LAMP.
REPLACE WITH SAME SHARP LAMP UNIT TYPE BQC-PGM20X//1 ONLY.
UV RADIATION : CAN CAUSE EYE DAMAGE. TURN OFF LAMP BEFORE SERVICING.
MEDIUM PRESSURE LAMP : RISK OF EXPLOSION. POTENTIAL HAZARD OF GLASS PARTICLES IF LAMP HAS RUPTURED. HANDLE WITH CARE. SEE OPERATION MANUAL.



PRECAUTIONS A OBSERVER LORS DU REMPLACEMENT DE LA LAMPE.

DEBRANCHER LE CORDON D'ALIMENTATION AVANT DE RETIRER LES VIS.
L'INTERIEUR DU BOITIER ETANT EXTREMEMENT CHAUD, ATTENDRE 1 HEURE AVANT DE PROCEDER AU REMPLACEMENT DE LA LAMPE.
NE REMPLACER QUE PAR UNE LAMPE SHARP DE TYPE BQC-PGM20X//1.
RAYONS ULTRAVIOLETS : PEUVENT ENDOMMAGER LES YEUX.
ETEINDRE LA LAMPE AVANT DE PROCEDER A L'ENTRETIEN.
LAMPE A MOYENNE PRESSION : RISQUE D'EXPLOSION. DANGER POTENTIEL DE PARTICULES DE VERRE EN CAS D'ECLATEMENT DE LA LAMPE
A MANIPULER AVEC PRECAUTION, SE REPORTER AU MODE D'EMPLOI.

Outstanding Features

1. Image Quality

- Superior image quality with Fujinon™ optical lens system
- Newly developed DDR (Double Data Rate) chip eliminates Color Breaking phenomena common with previous generation DLP™ projectors.
- Newly developed 12° DMD™ chip provides significantly improved optical efficiency and excellent contrast ratio.

2. Light, Compact, and Unique Slim Design

- A new optical engine creates a unique slim design and compact size (4.2 liters, 5.8 lbs. (2.6 kg)).

3. Superior PC Compatibility

- Supports a refresh rate (vertical frequency) of up to 160 Hz and a wide range of synchronous signals.
- Using **Advanced Intelligent Compression Technology**, computer screens of SXGA+ (1,400 × 1,050) resolution can be displayed with minimal distortion.

4. Advanced Computer & Video Integrated Composer Technology

- **Realizes vivid images using the latest high image quality circuitry.**
 - **New I/P conversion algorithm enhances the performance of the motion detect I/P conversion.**
Extensive improvements on the jagged edges or slanted lines in moving images.
 - **Contrast Control Dynamic Gamma**
Improved contrast and natural color gradation by minimizing hue change.
 - **Color Management Function**
Supports sRGB (color management).
 - **Noise Reduction**
Allows for a clear image even with noisy source signals.
 - **New Edge Up-Scaling**
Reduces jaggies and flickering when up-scaling edges of slanted lines, enabling sharper quality images.

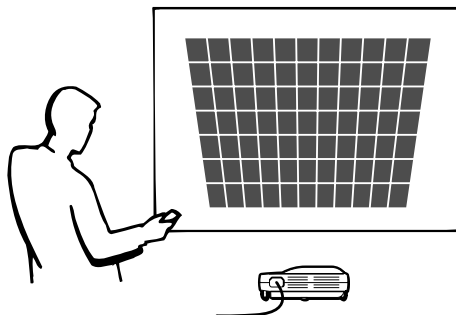

Contents

Introduction

Outstanding Features	3
Contents	4
IMPORTANT SAFEGUARDS	6
How to Access the PDF Operation Manuals	9
Part Names	10
Projector (Front and Top View)	10
Projector (Side View)	11
Remote Control	12
Using the Remote Control	13
Available Range of the Remote Control	13
Inserting the Batteries	13
Accessories	14

Setup and Connections

Setup	16
Using the Adjustment Feet	16
Setting up the Screen	17
Screen Size and Projection Distance	18
Projecting a Reversed/Inverted Image	19
Connecting the Projector to Other Devices	20
Before Connecting	20
This projector can be connected to:	20
Connecting the Power Cord	20
Connecting the Projector to a Computer	21
Connecting to Video Equipment	23
Connecting to a Monitor	25
Using the Wireless Presentation Function of the Remote Control	26

Basic Operation

Setting with the Buttons	
Image Projection	28
Basic Procedure	28
Selecting the On-screen Display Language	30
Adjusting the Lens	31
Correcting Trapezoidal Distortion (Keystone Correction)	32
Setting with the Menus	
Menu Bar Items	34
Using the Menu Screen	36
Basic Operations (Adjustments)	36
Basic Operations (Settings)	38

Adjusting the Picture	40
Adjusting Image Preferences	40
Selecting the Signal Type	40
Progressive Mode	41
Adjusting Computer Images	42
When Auto Sync is OFF	42
Saving Adjustment Settings	42
Selecting Adjustment Settings	43
Special Mode settings	43
Checking the Input Signal	43
Auto Sync Adjustment	44
Auto Sync Display Function	44

Easy to Use Functions

Selecting the Picture Display Mode	46
Displaying a Still Image	48
Enlarging a Specific Portion of an Image	49
Gamma Correction Function	50
Displaying Dual Pictures (Pict in Pict)	51
Selecting the Power Save Mode	52
Setting the Power Save Mode	52
Automatic Power Shutoff Function	52
Activating the sRGB Color Management Function	53
Auto Search Function	53
Video Digital Noise Reduction (DNR) System	54
Setting the On-screen Display	54
Setting the Video System	55
Saving Projected Images	56
Capturing the Image	56
Deleting the Captured Image	56
Setting a Background Image	57
Selecting a Startup Image	57
Using an RGB Monitor Loop-out Adaptor	58
Displaying the Lamp Usage Time	58
Displaying the Break Timer	59
Reversing/Inverting Projected Images	60
Locking the Operation	
Buttons on the Projector	60
Setting up the Keylock	60
Canceling the Keylock Setting	61
Setting up a Password	61
Entering the Password	61
Changing the Password	62
If You Forget Your Password	62

Setting the Anti-Theft	63
Entering the Keycode	63
Changing the Keycode	64
Initializing the Settings	65
Displaying the Adjustment Settings	66

Appendix

Carrying the Projector	68
Maintenance	69
Maintenance Indicators	70
Regarding the Lamp	71
Lamp	71
Caution Concerning the Lamp	71
Replacing the Lamp	71
Removing and Installing the Lamp Unit	72
Resetting the Lamp Timer	73
Connecting Pin Assignments	74
Computer Compatibility Chart	75
Troubleshooting	76
For SHARP Assistance	78
Specifications	79
Dimensions	80
Glossary	81
Index	82

IMPORTANT SAFEGUARDS

CAUTION: Please read all of these instructions before you operate this product and save these instructions for later use.

Electrical energy can perform many useful functions. This product has been engineered and manufactured to assure your personal safety. BUT IMPROPER USE CAN RESULT IN POTENTIAL ELECTRICAL SHOCK OR FIRE HAZARDS. In order not to defeat the safeguards incorporated in this product, observe the following basic rules for its installation, use and servicing.

1. Read Instructions

All the safety and operating instructions should be read before the product is operated.

2. Retain Instructions

The safety and operating instructions should be retained for future reference.

3. Heed Warnings

All warnings on the product and in the operating instructions should be adhered to.

4. Follow Instructions

All operating and use instructions should be followed.

5. Cleaning

Unplug this product from the wall outlet before cleaning. Do not use liquid cleaners or aerosol cleaners. Use a damp cloth for cleaning.

6. Attachments

Do not use attachments not recommended by the product manufacturer as they may cause hazards.

7. Water and Moisture

Do not use this product near water—for example, near a bath tub, wash bowl, kitchen sink, or laundry tub; in a wet basement; or near a swimming pool; and the like.

8. Accessories

Do not place this product on an unstable cart, stand, tripod, bracket, or table. The product may fall, causing serious injury to a child or adult, and serious damage to the product. Use only with a cart, stand, tripod, bracket, or table recommended by the manufacturer, or sold with the product. Any mounting of the product should follow the manufacturer's instructions, and should use a mounting accessory recommended by the manufacturer.

9. Transportation

A product and cart combination should be moved with care. Quick stops, excessive force, and uneven surfaces may cause the product and cart combination to overturn.



10. Ventilation

Slots and openings in the cabinet are provided for ventilation to ensure reliable operation of the product and to protect it from overheating, and these openings must not be blocked or covered. The openings should never be blocked by placing the product on a bed, sofa, rug, or other similar surface. This product should not be placed in a built-in installation such as a bookcase or rack unless proper ventilation is provided or the manufacturer's instructions have been adhered to.

11. Power Sources

This product should be operated only from the type of power source indicated on the marking label. If you are not sure of the type of power supply to your home, consult your product dealer or local power company. For products intended to operate from battery power, or other sources, refer to the operating instructions.

12. Grounding or Polarization

This product is provided with one of the following types of plugs. If the plug should fail to fit into the power outlet, please contact your electrician.

Do not defeat the safety purpose of the plug.

- Two-wire type (mains) plug.
- Three-wire grounding type (mains) plug with a grounding terminal.

This plug will only fit into a grounding type power outlet.

13. Power-Cord Protection

Power-supply cords should be routed so that they are not likely to be walked on or pinched by items placed upon or against them, paying particular attention to cords at plugs, convenience receptacles, and the point where they exit from the product.

14. Lightning

For added protection for this product during a lightning storm, or when it is left unattended and unused for long periods of time, unplug it from the wall outlet and disconnect the cable system. This will prevent damage to the product due to lightning and power-line surges.

15. Overloading

Do not overload wall outlets, extension cords, or integral convenience receptacles as this can result in a risk of fire or electric shock.

16. Object and Liquid Entry

Never push objects of any kind into this product through openings as they may touch dangerous voltage points or short-out parts that could result in a fire or electric shock. Never spill liquid of any kind on the product.

17. Servicing

Do not attempt to service this product yourself as opening or removing covers may expose you to dangerous voltage or other hazards. Refer all servicing to qualified service personnel.

18. Damage Requiring Service

Unplug this product from the wall outlet and refer servicing to qualified service personnel under the following conditions:

- a. When the power-supply cord or plug is damaged.
- b. If liquid has been spilled, or objects have fallen into the product.
- c. If the product has been exposed to rain or water.
- d. If the product does not operate normally by following the operating instructions. Adjust only those controls that are covered by the operating instructions, as an improper adjustment of other controls may result in damage and will often require extensive work by a qualified technician to restore the product to normal operation.
- e. If the product has been dropped or damaged in any way.
- f. When the product exhibits a distinct change in performance, this indicates a need for service.

19. Replacement Parts

When replacement parts are required, be sure the service technician has used replacement parts specified by the manufacturer or have the same characteristics as the original part. Unauthorized substitutions may result in fire, electric shock, or other hazards.

20. Safety Check

Upon completion of any service or repairs to this product, ask the service technician to perform safety checks to determine that the product is in proper operating condition.

21. Wall or Ceiling Mounting

This product should be mounted to a wall or ceiling only as recommended by the manufacturer.

22. Heat

This product should be situated away from heat sources such as radiators, heat registers, stoves, or other products (including amplifiers) that produce heat.

INTELLECTUAL PROPERTY RIGHTS IMPORTANT READ BEFORE USING THE PRODUCT

- You have acquired a product that includes software licensed to SHARP Corporation by Lineo, Inc. ("Lineo"). The Software is protected by copyright laws, international copyright treaties, and other intellectual property laws and treaties. Lineo and its suppliers retain all ownership of, and intellectual property rights in (including copyright), the Software components and all copies thereof, provided however, that certain components of the Software are components licensed under the GNU General Public License (version 2), which Lineo supports. You may obtain a copy of the GNU General Public License at <http://www.fsf.org/copyleft/gpl.html>. Lineo will provide source code for any of the components of the Software licensed under the GNU General Public License. To obtain such source code, send email to embedix-support@lineo.com.
- OS: Embedix (Embedded Linux) Embedix™ is a registered trademark of U.S.A. LINEO, Inc.
- DLP™ (Digital Light Processing) and DMD™ (Digital Micromirror Device) are trademarks of Texas Instruments, Inc.
- Microsoft and Windows are registered trademarks of Microsoft Corporation, in the United States and/or other countries.
- PC/AT is a registered trademark of International Business Machines Corporation in the United States.
- Adobe Acrobat is a trademark of Adobe Systems Incorporated.
- Macintosh is a registered trademark of Apple Computer, Inc. in the United States and/or other countries.
- All other company or product names are trademarks or registered trademarks of their respective companies.
- Some IC chips in this product include confidential and/or trade secret property belonging to Texas Instruments. Therefore you may not copy, modify, adapt, translate, distribute, reverse engineer, reverse assemble or discompile the contents thereof.

IMPORTANT SAFEGUARDS (cont.)

Be sure to read the following safeguards when setting up your projector.

Caution concerning the lamp unit

- Potential hazard of glass particles if lamp ruptures. In case of lamp rupture, contact your nearest Sharp Authorized Projector Dealer or Service Center for a replacement.

See "Replacing the Lamp" on page 71.

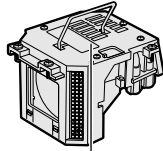

Cautions concerning the setup of the projector

- For minimal servicing and to maintain high image quality, SHARP recommends that this projector be installed in an area free from humidity, dust and cigarette smoke. When the projector is subjected to these environments, the lens must be cleaned more often. As long as the projector is regularly cleaned, use in these environments will not reduce the overall operation life of the unit. Internal cleaning should only be performed by a Sharp Authorized Projector Dealer or Service Center.

Do not set up the projector in places exposed to direct sunlight or bright light.

- Position the screen so that it is not in direct sunlight or room light. Light falling directly on the screen washes out the colors, making viewing difficult. Close the curtains and dim the lights when setting up the screen in a sunny or bright room.

Tilt the projector so that it does not go over an angle of 10 degrees when setting it.

- The placement range (the horizontal angle) should be within ± 10 degrees.

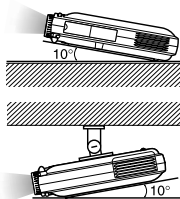
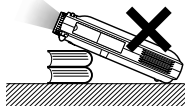

Do not subject the projector to hard impact and/or vibration.

- Take care with the lens so as not to hit or damage the surface of the lens.

Rest your eyes occasionally.

- Continuously watching the screen for long hours will make your eyes tired. Be sure to rest your eyes sometimes.

Avoid locations with high or low temperature.

- The operating temperature for the projector is from 41°F to 95°F (+5°C to +35°C)
- The storage temperature for the projector is from -4°F to 140°F (-20°C to +60°C)

Do not block the exhaust and intake vents.

- Allow at least 11.8 inches (30 cm) of space between the exhaust vent and the nearest wall or obstruction.

- Be sure that the intake vent and the exhaust vent are not obstructed.
- If the cooling fan becomes obstructed, a protection circuit will automatically turn off the projector. This does not indicate a malfunction. Remove the projector power cord from the wall outlet and wait at least 10 minutes. Place the projector where the intake and exhaust vents are not blocked, plug the power cord back in and turn on the projector. This will return the projector to the normal operating condition.

Cautions regarding the transportation of the projector

- When transporting the projector, be sure not to subject it to hard impact and/or vibration, as this can result in damage. Take extra caution with the lens. Before moving the projector, be sure to unplug the power cord from the wall outlet, and disconnect any other cables connected to it.

Other connected equipment

- When connecting a computer or other audio-visual equipment to the projector, make the connections AFTER turning off the projector and the equipment to be connected.
- Please read the operation manuals of the projector and the equipment to be connected for instructions on how to make the connections.

Using the projector in other Countries

- The power supply voltage and the shape of the plug may vary depending on the region or country you are using the projector in. When using the projector overseas, be sure to use the appropriate power cord for the country you are in.

Temperature monitor function

- If the projector starts to overheat due to setup problems or blockage of the air vents, "X" and "TEMP." will blink in the lower left corner of the picture. If the temperature continues to rise, the lamp will turn off, the TEMPERATURE WARNING indicator on the projector will blink, and after a 90-second cooling-off period the power will shut off. Refer to "Maintenance Indicators" on page 70 for details.



Info

- The cooling fan regulates the internal temperature, and its performance is automatically controlled. The sound of the fan may change during projector operation due to changes in the fan speed. This does not indicate malfunction.
- Do not unplug the power cord during projection or cooling fan operation. This can create damage due to the rise in internal temperature, as the cooling fan also stops.

How to Access the PDF Operation Manuals

PDF operation manuals in several languages are included in the CD-ROM. To utilize these manuals, you need to install Adobe Acrobat Reader on your PC (Windows or Macintosh). If you have not installed Acrobat Reader yet, you can download it from the Internet (<http://www.adobe.com>) or install it from the CD-ROM.

To install Acrobat Reader from the CD-ROM

For Windows:

- ① Insert the CD-ROM in the CD-ROM drive.
- ② Double click on the "My Computer" icon.
- ③ Double click on the "CD-ROM" drive.
- ④ Double click on the "acrobat" folder.
- ⑤ Double click on the "windows" folder.
- ⑥ Double click on the desired installation program and follow the instructions on the screen.

For Macintosh:

- ① Insert the CD-ROM in the CD-ROM drive.
- ② Double click on the "CD-ROM" icon.
- ③ Double click on the "acrobat" folder.
- ④ Double click on the "mac" folder.
- ⑤ Double click on the desired installation program and follow the instructions on the screen.

For other operating systems:

Please download Acrobat Reader from the Internet (<http://www.adobe.com>).

For other languages:

If you prefer using Acrobat Reader for languages other than those included in the CD-ROM, please download the appropriate version from the Internet.

Accessing the PDF Manuals

For Windows:

- ① Insert the CD-ROM in the CD-ROM drive.
- ② Double click on the "My Computer" icon.
- ③ Double click on the "CD-ROM" drive.
- ④ Double click on the "manuals" folder.
- ⑤ Double click on the "pgm20s" folder.
- ⑥ Double click on the language (name of the folder) that you want to view.
- ⑦ Double click on the pdf file.

For Macintosh:

- ① Insert the CD-ROM in the CD-ROM drive.
- ② Double click on the "CD-ROM" icon.
- ③ Double click on the "manuals" folder.
- ④ Double click on the "pgm20s" folder.
- ⑤ Double click on the language (name of the folder) that you want to view.
- ⑥ Double click on the pdf file.



Note

- If the desired PDF file cannot be opened by double clicking the mouse, start Acrobat Reader first, then specify the desired file using the "File", "Open" menu.
- See the "readme.txt" file on the CD-ROM for important information on the CD-ROM not included in this operation manual.

Part Names

Projector (Front and Top View)

LAMP REPLACEMENT indicator

Illuminates green indicating normal function. Replace the lamp when the indicator illuminates red.

POWER indicator

Illuminates in red, when the projector is in standby. When the power is turned on, this indicator will illuminate green.

POWER button

Turns the power on or off.

LENS button

For adjusting Keystone or Digital Shift setting.

Adjustment buttons

()
For selecting menu items.

ENTER button

For setting items selected or adjusted on the menu.

AV MUTE button

For temporarily turning off the sound and picture.

Zoom knob

Foot releases/Adjustment feet

For adjusting the projector's height.

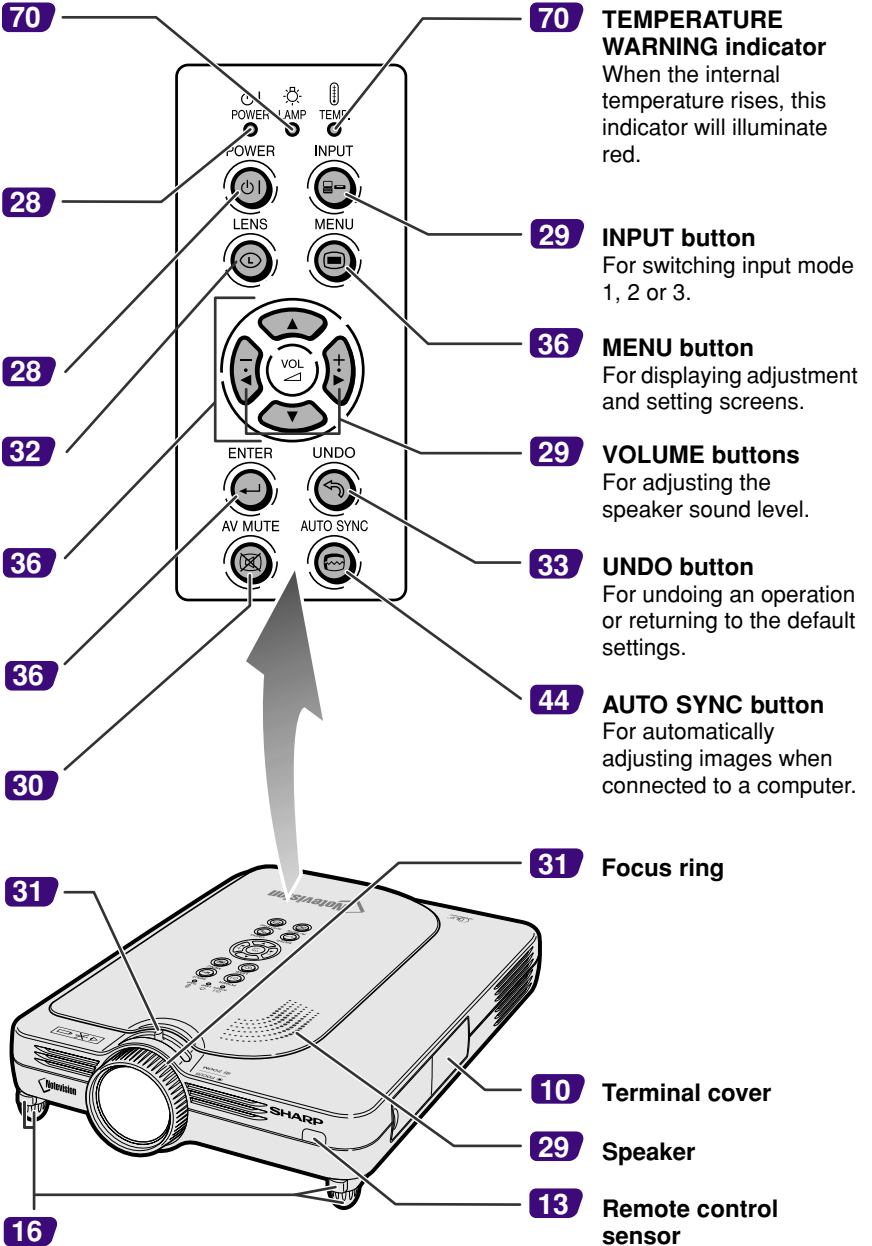

TEMPERATURE WARNING indicator

When the internal temperature rises, this indicator will illuminate red.

INPUT button

For switching input mode 1, 2 or 3.

MENU button

For displaying adjustment and setting screens.

VOLUME buttons

For adjusting the speaker sound level.

UNDO button

For undoing an operation or returning to the default settings.

AUTO SYNC button

For automatically adjusting images when connected to a computer.

Focus ring

Terminal cover

Speaker

Remote control sensor

Attaching the terminal cover

Attach the terminal cover by placing it on the side panel of the projector and pressing it into place, as shown in the illustration.

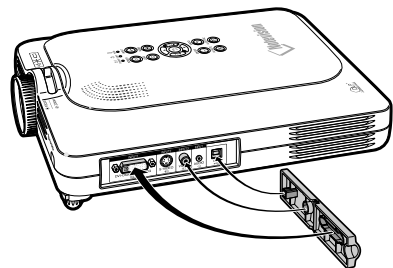

Projector (Side View)

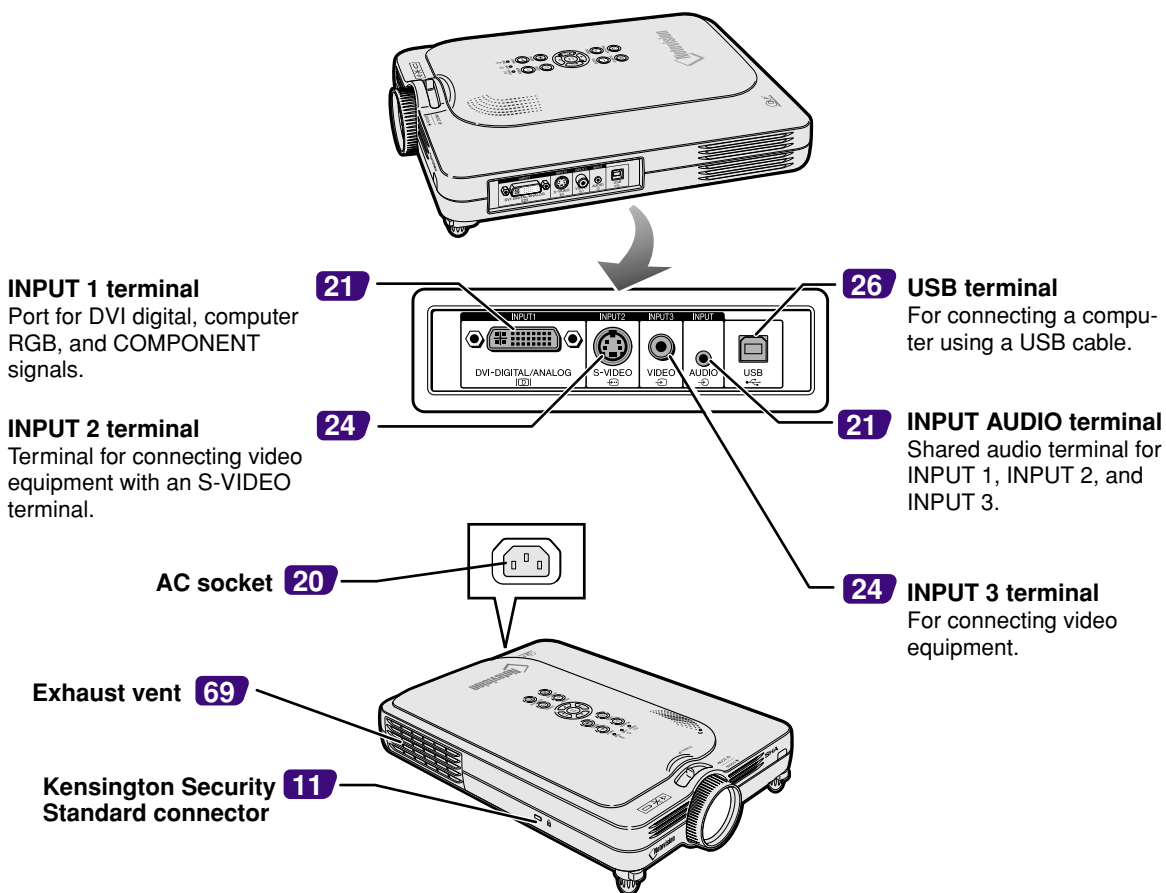

Using the Kensington Lock

- This projector has a Kensington Security Standard connector for use with a Kensington MicroSaver Security System. Refer to the information that came with the system for instructions on how to use it to secure the projector.

Attaching the lens cap

After putting the lens cap strap on the lens cap, pass the other end of the strap through the hole under the projector, next to the lens, as shown in the illustration.

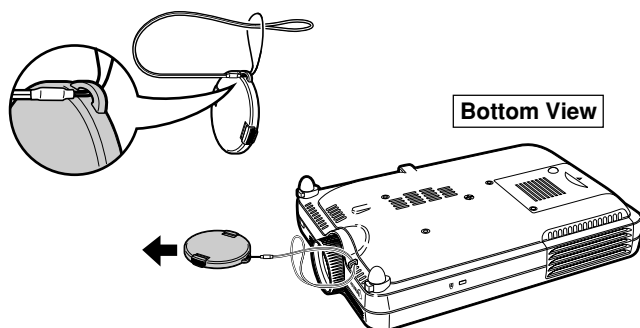

Part Names (cont.)

Remote Control

Remote control signal transmitter

FORWARD/BACK button

Moves forward or backwards when connected to a computer using a USB cable. Same as the [Page Down] and [Page Up] keys on a computer keyboard.

AV MUTE button

For temporarily turning off the sound and picture.

VOLUME buttons

For adjusting the speaker sound level.

INPUT 2 button

For switching the input mode to INPUT 2.

INPUT 1 button

For switching the input mode to INPUT 1.

AUTO SYNC button

For automatically adjusting images when connected to a computer.

LENS button

For adjusting Keystone or Digital Shift setting.

ENTER button

For setting items selected or adjusted on the menu.

26

30

29

29

29

44

32

36

28

49

48

29

46

50

36

36

33

POWER button

Turns the power on or off.

ENLARGE (Enlarge/Reduce) buttons

For enlarging or reducing part of the image.

FREEZE button

For freezing images.

INPUT 3 button

For switching the input mode to INPUT 3.

RESIZE button

For switching the screen size (NORMAL, BORDER, etc).

GAMMA button

For correcting the brightness of an image, when the images displayed are hard to see because of the brightness of the room. Four gamma modes are available to choose from.

MENU button

For displaying adjustment and setting screens.

Adjustment buttons

(◀ ▶ ▲ ▼)

For selecting menu items.

UNDO button

For undoing an operation or returning to the default settings.

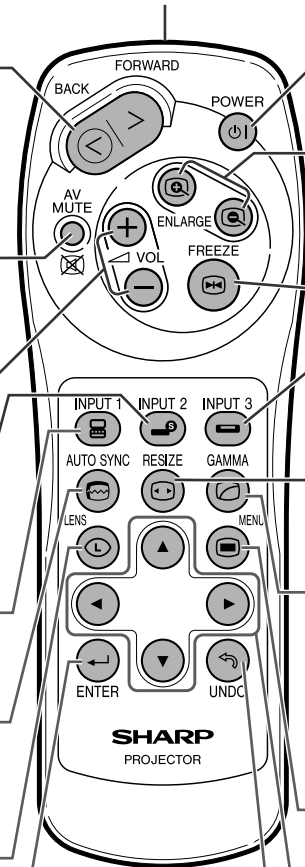

Using the Remote Control

Available Range of the Remote Control

- The remote control can be used to control the projector within the ranges shown in the illustration.

Note

- The signal from the remote control can be reflected off a screen for easy operation. However, the effective distance of the signal may differ due to the screen material.

When using the remote control:

- Be sure not to drop, expose to moisture or high temperature.
- The remote control may malfunction under a fluorescent lamp. Under that circumstance, move the projector away from the fluorescent lamp.

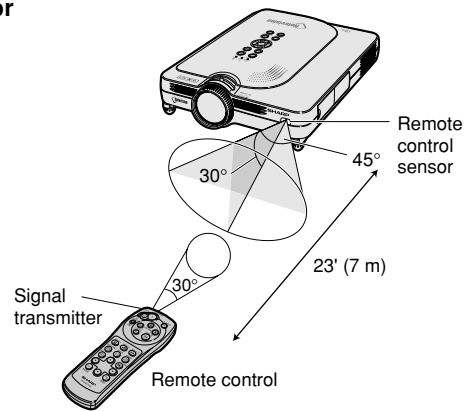

Inserting the Batteries

The batteries (two R-03 batteries (“AAA” size, UM/SUM-4, HP-16 or similar)) are included in the package.

1 Slide the cover in the direction of the arrow to open it.

2 Insert the included batteries.

- Insert the batteries making sure the polarities correctly match the ⊕ and ⊖ marks inside the battery compartment.

3 Slide the cover in the direction of the arrow to close it.

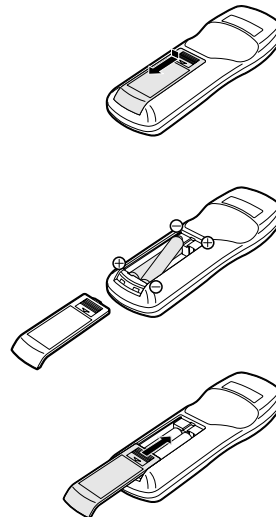

Incorrect use of the batteries may cause them to leak or explode. Please follow the precautions below.

⚠ Caution

- Insert the batteries making sure the polarities correctly match the ⊕ and ⊖ marks inside the battery compartment.
- Batteries of different types have different properties, therefore do not mix batteries of different types.
- Do not mix new and old batteries.
This may shorten the life of new batteries or may cause old batteries to leak.
- Remove the batteries from the remote control once they have run out, as leaving them can cause them to leak. Battery fluid from leaked batteries is harmful to your skin, therefore be sure to first wipe them and then remove them using a cloth.

- The batteries included with this projector may be exhausted over a short period, depending on how they are kept. Be sure to replace them as soon as possible with new batteries.
- Remove the batteries from the remote control if you will not be using the remote control for a long time.

Accessories

Supplied accessories



Remote control
RRMCGA013WJSA



Two R-03 batteries
("AAA" size, UM/SUM-4, HP-16 or similar)

Power cord (6' (1.8m))

(1)

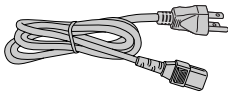

For U.S., Canada, etc.
QACCCA007WJPZ

(2)

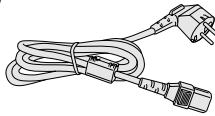

For Europe, except U.K.
QACCV4002CEZZ

(3)

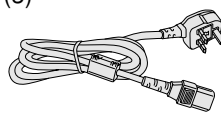

For U.K., Hong Kong
and Singapore
QACCA012WJPZ

(4)

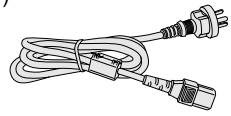

For Australia, New
Zealand and Oceania
QACCL3022CEZZ

Note

- Depending on the region, projectors only ship with one power cord (see above). Use the power cord that corresponds to the wall outlet in your country.

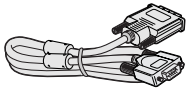

DVI to 15-pin D-sub
cable (6' (1.8m))
QCNWGA010WJZZ

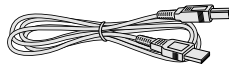

USB cable
(6' (1.8 m))
QCNWG0001WJPZ

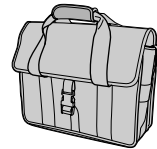

Carrying case
GCASN0005CESA

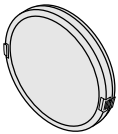

Lens cap
(attached)
CCAPHA001WJ01

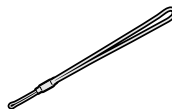

Lens cap strap
UBNDT0013CEZZ

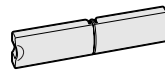

Terminal cover
(attached)
GCOVD0103CESA

CD-ROM
UDSKAA009WJZZ

Operation manual
(this manual)

Quick reference guides

Optional cables

DVI cable (9'10" (3.0 m))

3 RCA to 15-pin D-sub cable (9'10" (3.0 m))

Computer RGB cable (32'10" (10.0 m))

AN-C3DV

AN-C3CP

AN-C10BM

<for IBM-PC, PC9821, and PC98NX series>

AN-C10MC

<for Macintosh series>

AN-C10PC

<for PC98 series (Except PC9821 and PC98NX series)>

5 BNC to 15-pin D-sub cable (9'10" (3.0 m))

RGB monitor loop-out adaptor (7.9" (20 cm))

DVI to 15-pin D-sub adaptor (7.9" (20 cm))

AN-C3BN

AN-A1MY

AN-A1DV

- If you cannot connect after changing computer ports, be sure to check you computer's specifications. If you are still having difficulty connecting, a conversion connector (commercially available) may be necessary.

Note

- All cables may not be available in all regions. Please check with your nearest Sharp Authorized Projector Dealer or Service Center.

Setup and Connections

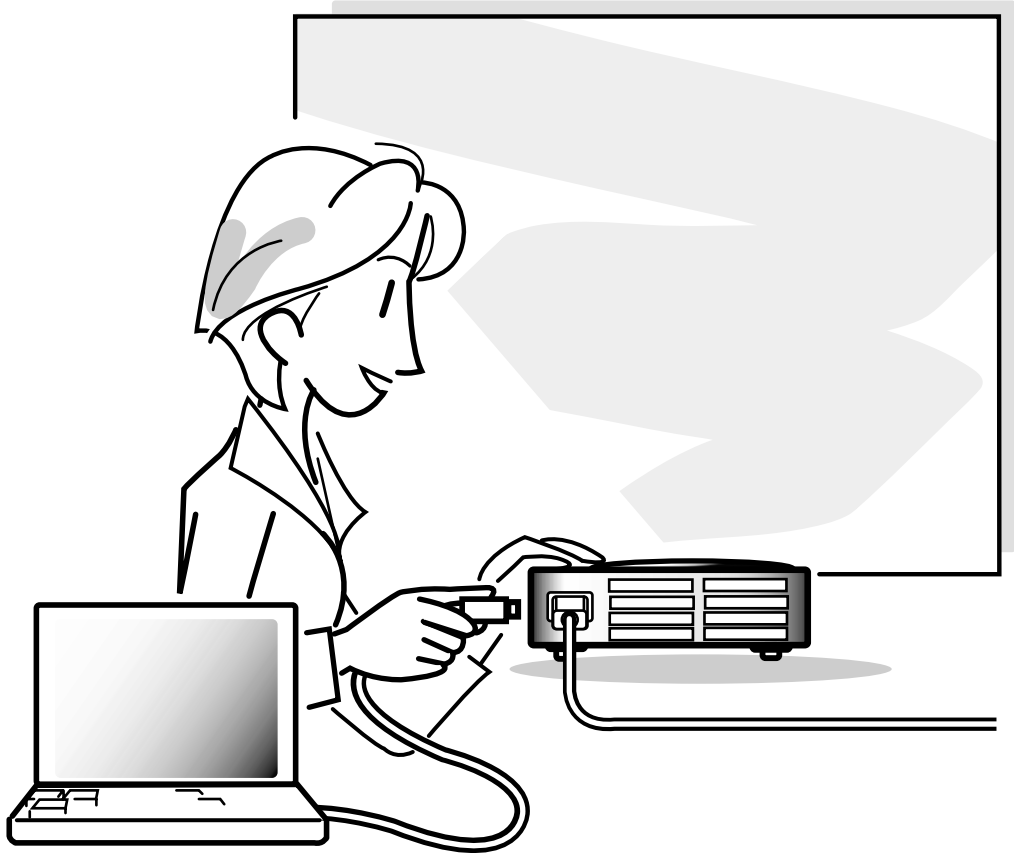

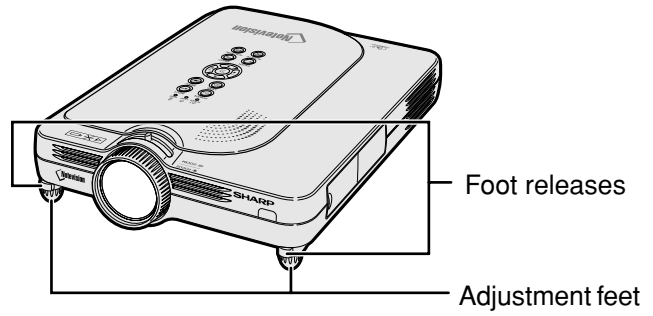

Using the Adjustment Feet

The height of the projector can be adjusted using the adjustment feet when the surface of the projector is placed on is uneven or when the screen is slanted.

The projection of the image can be made higher by adjusting the projector when it is in a location lower than the screen.

1 Press the foot releases.

2 Lift the projector to adjust its height and remove your hands from the foot releases.

3 Rotate the adjustment feet to make minor changes.

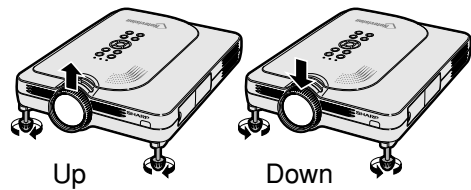
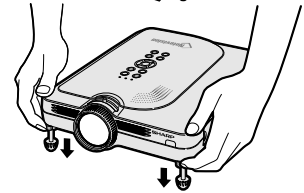
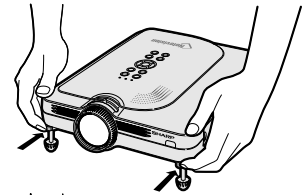

Note

- When returning the projector to its original position, hold the projector firmly, press the foot releases and then lower it.
- The projector is adjustable up to approximately 5.5 degrees from the standard position.

Info

- Do not press the foot releases when the feet are extended without firmly holding the projector.
- Do not hold the lens when lifting or lowering the projector.
- When lowering the projector, be careful not to get your fingers caught in the area between the adjustment feet and the projector.

Setting up the Screen

Position the projector perpendicular to the screen with all feet flat and level to achieve an optimal image.

Note

- The projector lens should be centered in the middle of the screen. If the horizontal line passing through the lens center is not perpendicular to the screen, the image will be distorted, making viewing difficult.
- For optimal image, position the screen so that it is not in direct sunlight or room light. Light falling directly on the screen washes out the colors, making viewing difficult. Close the curtains and dim the lights when setting up the screen in a sunny or bright room.
- A polarizing screen cannot be used with this projector.

Standard Setup (Front Projection)

- Place the projector at the required distance from the screen according to the desired picture size. (See page 18.)

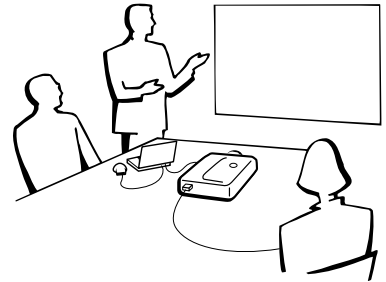

Example of Standard Setup

Side View

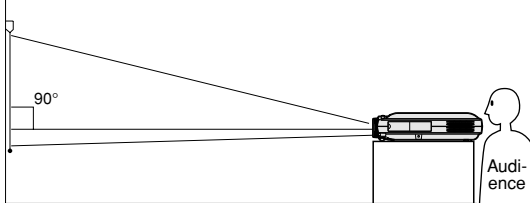

- The distance from the screen to the projector may vary depending on the size of the screen. [P.18](#)

- The default setting can be used, when placing the projector in front of the screen. If the projected image is reversed or inverted, re-adjust the setting to “Front” in “PRJ Mode”. [P.60](#)

Top View

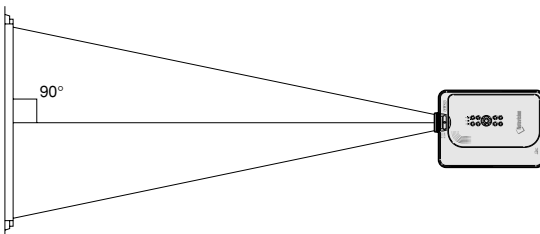

- Place the projector so that the horizontal line that passes through the center of the lens is perpendicular to the screen.

Setup (cont.)

Screen Size and Projection Distance

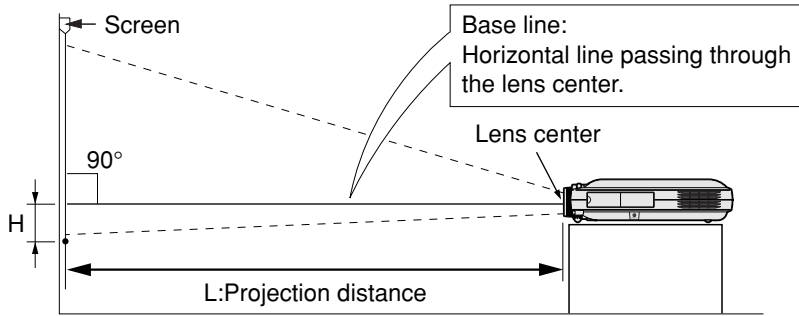

NORMAL Mode (4:3)

Picture (Screen) size			Projection distance (L)		Distance from the lens center to the bottom of the image (H)
Diag. (X)	Width	Height	Maximum (L1)	Minimum (L2)	
300" (762 cm)	240" (610 cm)	180" (457 cm)	-	50' 6" (15.4 m)	-25 28/64" (-64.6 cm)
250" (635 cm)	200" (508 cm)	150" (381 cm)	50' 10" (15.5 m)	42' 1" (12.8 m)	-21 13/64" (-53.8 cm)
200" (508 cm)	160" (406 cm)	120" (305 cm)	40' 7" (12.4 m)	33' 8" (10.3 m)	-16 61/64" (-43.1 cm)
150" (381 cm)	120" (305 cm)	90" (229 cm)	30' 5" (9.3 m)	25' 2" (7.7 m)	-12 46/64" (-32.3 cm)
100" (254 cm)	80" (203 cm)	60" (152 cm)	20' 3" (6.2 m)	16' 9" (5.1 m)	-8 31/64" (-21.5 cm)
84" (213 cm)	67" (170 cm)	50" (127 cm)	17' 0" (5.2 m)	14' 1" (4.3 m)	-7 8/64" (-18.1 cm)
72" (183 cm)	58" (147 cm)	43" (109 cm)	14' 6" (4.4 m)	12' 0" (3.7 m)	-6 7/64" (-15.5 cm)
60" (152 cm)	48" (122 cm)	36" (91 cm)	12' 1" (3.7 m)	10' 0" (3.0 m)	-5 6/64" (-12.9 cm)
40" (102 cm)	32" (81 cm)	24" (61 cm)	8' 0" (2.4 m)	6' 8" (2.0 m)	-3 25/64" (-8.6 cm)

The formula for picture size and projection distance
 L1 (ft)
 $= (0.062081X - 0.038676) / 0.3048$
 L2 (ft)
 $= (0.051456X - 0.038901) / 0.3048$
 H (in) = -0.0848X

X: Picture size (diag.) (in)
 L: Projection distance (m)
 L1: Maximum projection distance (ft)
 L2: Minimum projection distance (ft)
 H: Distance from the lens center to the bottom of the image (in)

STRETCH Mode (16:9)

Picture (Screen) size			Projection distance (L)		Distance from the lens center to the bottom of the image (H)
Diag. (X)	Width	Height	Maximum (L1)	Minimum (L2)	
250" (635 cm)	218" (554 cm)	123" (312 cm)	-	45' 10" (14.0 m)	-43 34/64" (-110.6 cm)
225" (572 cm)	196" (498 cm)	110" (279 cm)	49' 10" (15.2 m)	41' 3" (12.6 m)	-39 11/64" (-99.5 cm)
200" (508 cm)	174" (442 cm)	98" (249 cm)	44' 3" (13.5 m)	36' 8" (11.2 m)	-34 52/64" (-88.4 cm)
150" (381 cm)	131" (333 cm)	74" (188 cm)	33' 2" (10.1 m)	27' 6" (8.4 m)	-26 7/64" (-66.3 cm)
133" (338 cm)	116" (295 cm)	65" (165 cm)	29' 5" (9.0 m)	24' 4" (7.4 m)	-23 10/64" (-58.8 cm)
106" (269 cm)	92" (234 cm)	52" (132 cm)	23' 5" (7.1 m)	19' 4" (5.9 m)	-18 29/64" (-46.9 cm)
100" (254 cm)	87" (221 cm)	49" (124 cm)	22' 1" (6.7 m)	18' 3" (5.6 m)	-17 26/64" (-44.2 cm)
92" (234 cm)	80" (203 cm)	45" (114 cm)	20' 3" (6.2 m)	16' 10" (5.1 m)	-16 1/64" (-40.7 cm)
84" (213 cm)	73" (185 cm)	41" (104 cm)	18' 6" (5.6 m)	15' 4" (4.7 m)	-14 40/64" (-37.1 cm)
72" (183 cm)	63" (160 cm)	35" (89 cm)	15' 10" (4.8 m)	13' 1" (4.0 m)	-12 34/64" (-31.8 cm)
60" (152 cm)	52" (132 cm)	29" (74 cm)	13' 2" (4.0 m)	10' 11" (3.3 m)	-10 29/64" (-26.5 cm)
40" (102 cm)	35" (89 cm)	20" (51 cm)	8' 9" (2.7 m)	7' 3" (2.2 m)	-6 62/64" (-17.7 cm)

The formula for picture size and projection distance
 L1 (ft)
 $= (0.067635X - 0.038676) / 0.3048$
 L2 (ft)
 $= (0.056060X - 0.038901) / 0.3048$
 H (in) = -0.1741X

BORDER Mode (4:3)

Picture (Screen) size			Projection distance (L)		Distance from the lens center to the bottom of the image (H)
Diag. (X)	Width	Height	Maximum (L1)	Minimum (L2)	
200" (508 cm)	160" (406 cm)	120" (305 cm)	-	44' 11" (13.7 m)	-42 39/64" (-108.2 cm)
180" (457 cm)	144" (366 cm)	108" (274 cm)	48' 9" (14.9 m)	40' 5" (12.3 m)	-38 23/64" (-97.4 cm)
150" (381 cm)	120" (305 cm)	90" (229 cm)	40' 7" (12.4 m)	33' 8" (10.3 m)	-31 61/64" (-81.2 cm)
100" (254 cm)	80" (203 cm)	60" (152 cm)	27' 0" (8.2 m)	22' 5" (6.8 m)	-21 20/64" (-54.1 cm)
84" (213 cm)	67" (170 cm)	50" (127 cm)	22' 8" (6.9 m)	18' 9" (5.7 m)	-17 57/64" (-45.5 cm)
72" (183 cm)	58" (147 cm)	43" (109 cm)	19' 5" (5.9 m)	16' 1" (4.9 m)	-15 22/64" (-39.0 cm)
60" (152 cm)	48" (122 cm)	36" (91 cm)	16' 2" (4.9 m)	13' 5" (4.1 m)	-12 50/64" (-32.5 cm)
40" (102 cm)	32" (81 cm)	24" (61 cm)	10' 9" (3.3 m)	8' 11" (2.7 m)	-8 33/64" (-21.6 cm)

The formula for picture size and projection distance
 L1 (ft)
 $= (0.082775X - 0.038676) / 0.3048$
 L2 (ft)
 $= (0.068608X - 0.038901) / 0.3048$
 H (in) = -0.213072X



Note

- There is an error of ± 3% in the formula above.
- Values with a minus (-) sign indicate the distance of the lens center below the bottom of the image.

Projecting a Reversed/Inverted Image

Projection from behind the screen

- Place a translucent screen between the projector and the audience.
- Reverse the image by setting “Rear” in “PRJ Mode”. See page 60 for use of this function.

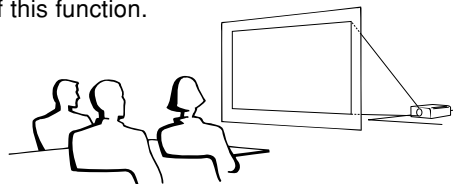

Projection using a mirror

- Place a mirror (normal flat type) in front of the lens.
- Reverse the image by setting “Rear” in “PRJ Mode”, when the mirror is placed on the audience side. See page 60 for use of this function.

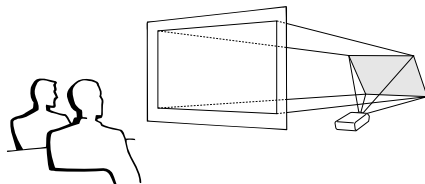

Info

- When using a mirror, be sure to carefully position both the projector and the mirror so the light does not shine into the eyes of the audience.

Ceiling-mount setup

- It is recommended that you use the optional Sharp ceiling-mount bracket for this installation. Before mounting the projector, contact your nearest Sharp Authorized Projector Dealer or Service Center to obtain the recommended ceiling-mount bracket (sold separately.) (AN-PGCM90 ceiling-mount bracket, its AN-EP101B extension tube and AN-JT200 universal bracket, adaptor for non-level ceiling installation (for U.S.A.), BB-M20T ceiling adaptor, its BB-NVHOLDER280, BB-NVHOLDER550, BB-NVHOLDER900 ceiling mount systems (for GERMANY), or AN-60KT ceiling-mount bracket, its AN-TK301/AN-TK201 and AN-TK302/AN-TK202 extension tubes (for countries other than the U.S.A. and GERMANY))
- Be sure to adjust the position of the projector to match the distance (H) from the lens center position (see page 18) to the lower edge of the image, when mounting the projector on the ceiling.
- Invert the image by setting “Ceiling + Front” in “PRJ Mode”.

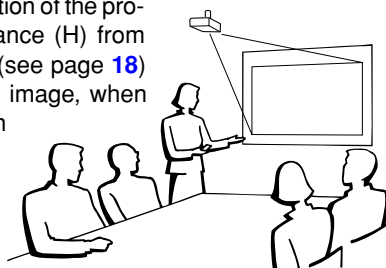

When using the default setting.

▼On-screen Display



The image is reversed.

When using the default setting.

▼On-screen Display



The image is reversed.

When using the default setting.

▼On-screen Display



The image is inverted.

Connecting the Projector to Other Devices

Before Connecting



Note

- Before connecting, be sure to turn off both the projector and the devices to be connected. After making all connections, turn on the projector and then the other devices.
When connecting a computer, be sure that it is the last device to be turned on after all the connections are made.
- Be sure to read the operation manuals of the devices to be connected before making connections.

This projector can be connected to:

A computer using:

- A DVI to 15-pin D-sub cable (See page 21.)
- A DVI cable (type AN-C3DV) (sold separately) (See page 22.)

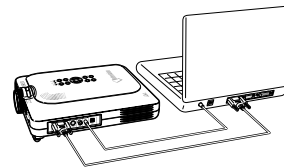

Component video or audio-visual equipment:

- A DVD player or DTV* decoder (See page 23.)
- A VCR, Laser disc player or other audio-visual equipment (See page 24.)

*DTV is the umbrella term used to describe the new digital television system in the United States.

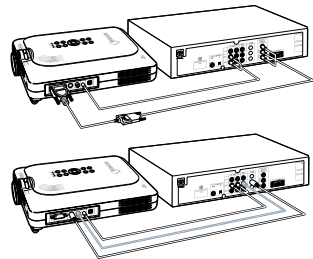

A monitor using:

- An RGB monitor loop-out adaptor (AN-A1MY) (sold separately) and an RGB cable (commercially available). (See page 25.)

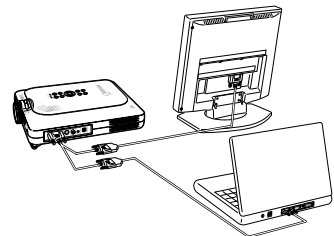

Connecting the Power Cord

- 1 Plug in the supplied power cord into the AC socket on the rear of the projector.

Supplied accessory

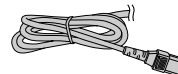

Power cord

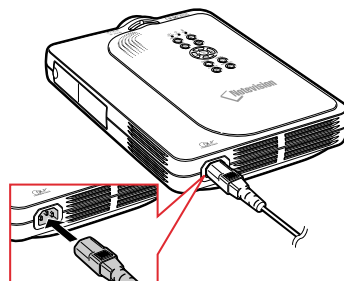

Connecting the Projector to a Computer

Connecting to a Computer Using the DVI to 15-pin D-sub Cable

1 Connect the projector to the computer using the supplied DVI to 15-pin D-sub cable.

- Secure the connectors by tightening the thumbscrews.

2 To input audio signal, connect the projector to the computer using a ø3.5 mm stereo audio cable (commercially available or available as Sharp service part QCNW-4870CEZZ).

Note

- See page 75 “Computer Compatibility Chart” for a list of computer signals compatible with the projector. Use with computer signals other than those listed may cause some of the functions not to work.
- When connecting the projector to a computer in this way, select “RGB” for “Signal Type” in the “Picture” menu. See page 40.
- A Macintosh adaptor may be required for use with some Macintosh computers. Contact your nearest Sharp Authorized Projector Dealer or Service Center.

Supplied accessory

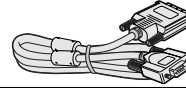

DVI to 15-pin D-sub cable

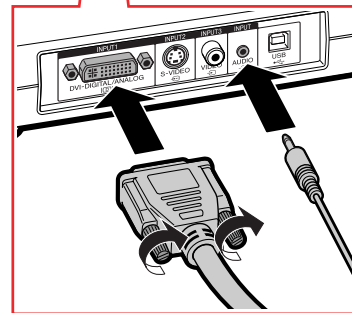
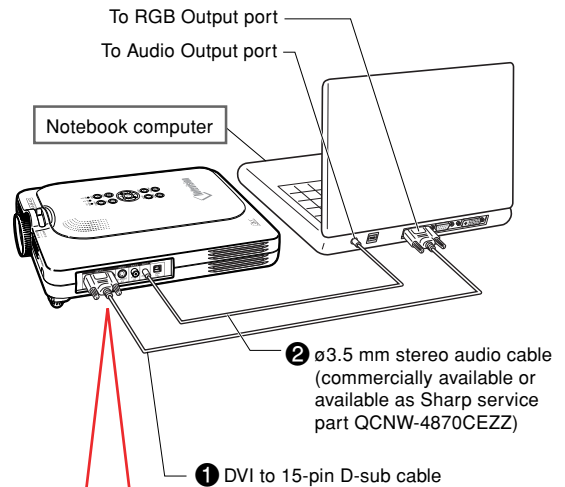

Connecting the thumbscrew cables

- Connect the thumbscrew cable making sure that it fits correctly into the port. Then, firmly secure the connectors by tightening the screws on both sides of the plug.
- Do not remove the ferrite core attached to the DVI to 15-pin D-sub cable.

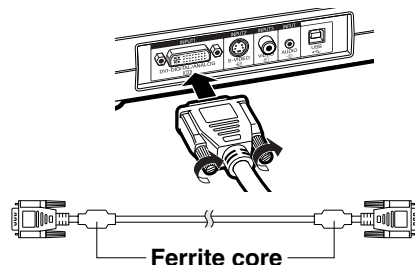

Connecting the Projector to Other Devices (cont.)

Connecting to a Computer Using a DVI Cable (Sold Separately)

This projector comes installed with a DVI digital input terminal in which computer digital image signals can be directly input.

1 Connect the projector to the computer using the DVI cable.

2 To input audio signal, connect the projector to the computer using a $\varnothing 3.5$ mm stereo audio cable (commercially available or available as Sharp service part QCNW-4870CEZZ).

Note

- This DVI port is DVI version 1.0 compatible. Therefore when the signal is input from copy guard system compatible (DVI version 2.0) equipment, no signal will be received.

Optional cable

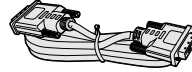

DVI cable
Type: AN-C3DV
(9'10" (3.0 m))

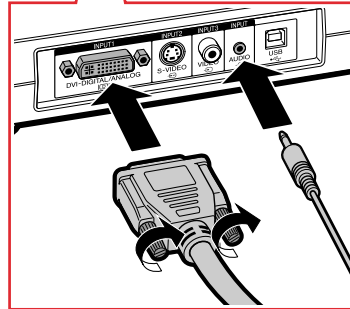
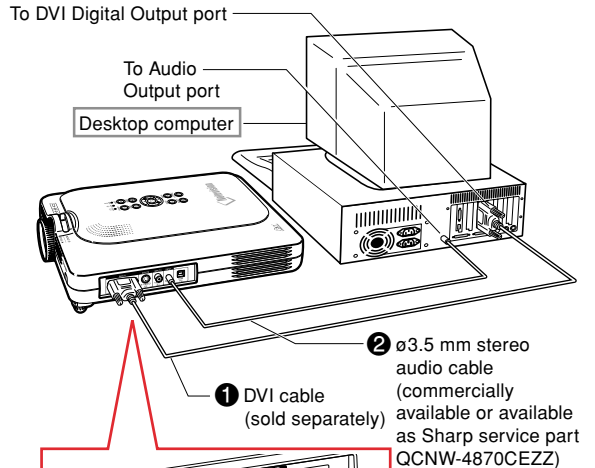

“Plug and Play” function (when connecting to a 15-pin terminal)

- This projector is compatible with VESA-standard DDC 1/DDC 2B. The projector and a VESA DDC compatible computer will communicate their setting requirements, allowing for quick and easy setup.
- Before using the “Plug and Play” function, be sure to turn on the projector first and the connected computer last.

Note

- The DDC “Plug and Play” function of this projector operates only when used in conjunction with a VESA DDC compatible computer.

Connecting to Video Equipment

Connecting to Component Video Equipment

Use a 3 RCA to 15-pin D-sub cable and DVI to 15-pin D-sub adaptor when connecting to the INPUT 1 terminal, component video equipment such as DVD players and DTV* decoders.

*DTV is the umbrella term used to describe the new digital television system in the United States.

- 1** Connect the 3 RCA to 15-pin D-sub cable using the DVI to 15-pin D-sub adaptor.
- 2** Use the above cables to connect the projector and the video equipment.
- 3** Connect the projector and the video equipment using a $\varnothing 3.5$ mm to RCA cable (commercially available).

Note

- When connecting the projector to the video equipment in this way, select "Component" for "Signal Type" in the "Picture" menu. See page 40.
- A $\varnothing 3.5$ mm stereo minijack to RCA audio cable (commercially available) is required for audio input.

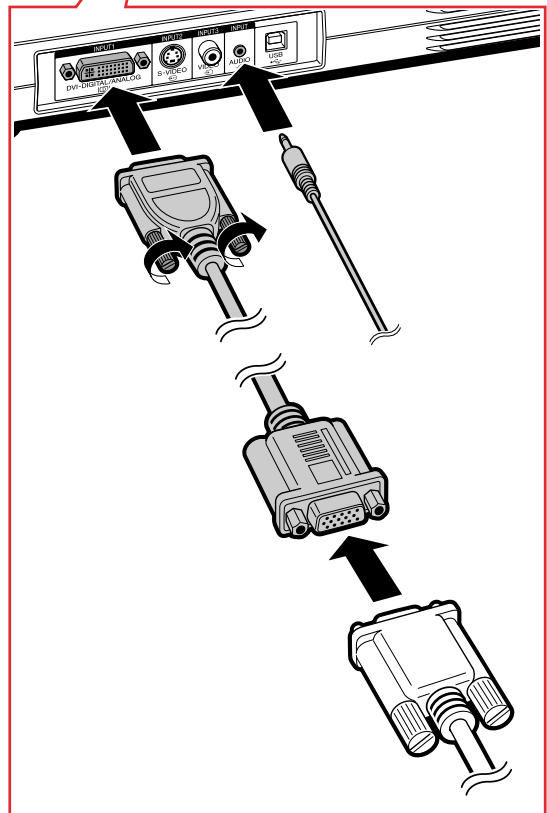
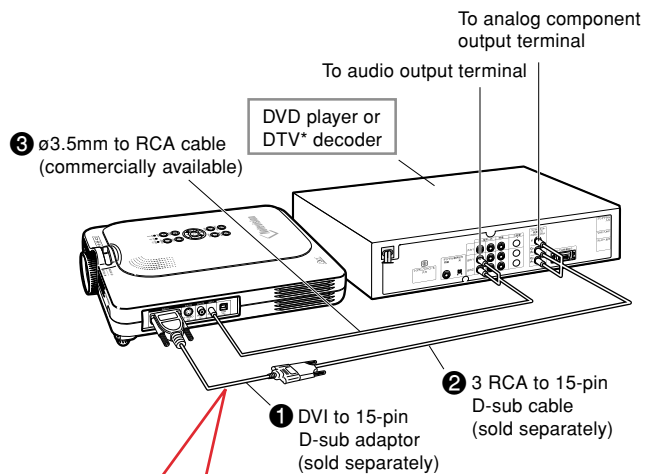
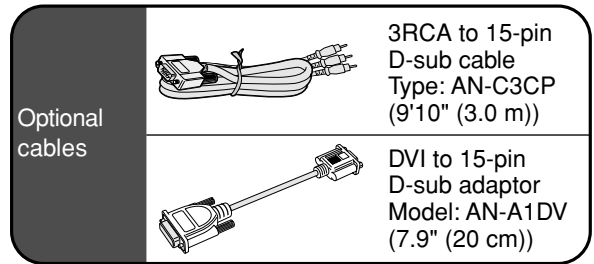

Connecting the Projector to Other Devices (cont.)

Connecting to Video Equipment Using an S-VIDEO, a Composite Video or an Audio Cable

Using an S-VIDEO, video, or audio cable, a VCR, laser disc player or other audio-visual equipment can be connected to INPUT 2, INPUT 3 and AUDIO terminals.

1 Connect the projector to the video equipment using an S-VIDEO cable or a composite video cable (both commercially available).

2 Connect the projector to the video equipment using a $\varnothing 3.5\text{mm}$ to RCA cable (commercially available).

Note

- The S-VIDEO INPUT terminal uses a video signal system in which the picture is separated into color and luminance signals to realize a higher-quality image. For realizing a higher-quality image, use a commercially available S-VIDEO cable to connect the S-VIDEO terminal on the projector and the S-VIDEO output terminal on the video equipment.
- A $\varnothing 3.5\text{ mm}$ minijack to RCA audio cable (commercially available) is required for audio input.

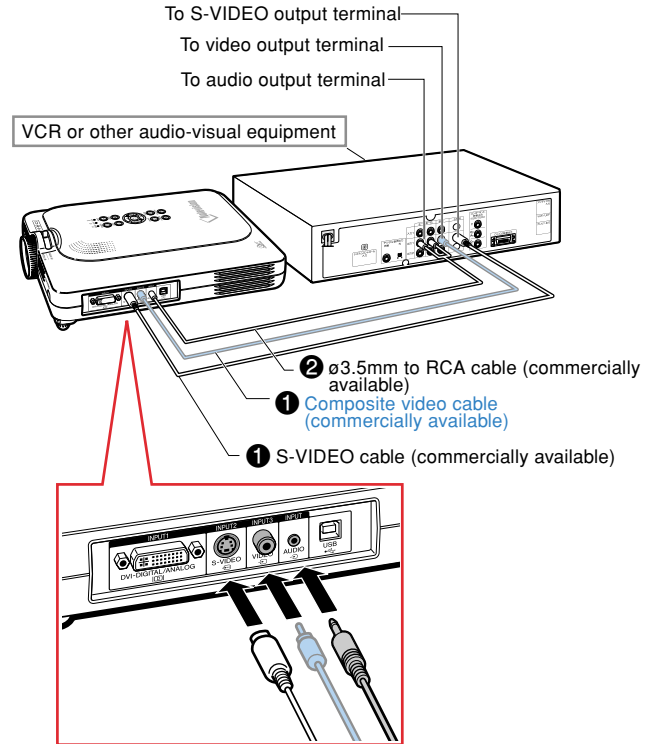

Connecting to a Monitor

Watching Images on Both the Projector and a Monitor

You can display computer images on both the projector and a separate monitor using an RGB monitor loop-out adaptor and an RGB cable.

1 Connect the projector to the computer and monitor using an RGB monitor loop-out adaptor (sold separately) and an RGB cable (commercially available).

2 In the “Options(1)” menu, select “Monitor Out” and then “Yes (Y cable)”.

- If “Disable” is selected, the projected image will be dimmer. This does not indicate a malfunction. For details, see page 58.

Note

- When using an RGB monitor loop-out adaptor (sold separately), make sure that the cable is connected to the monitor.
- Analog RGB signals as well as Component signals can be output to the monitor.

Info

- Only analog RGB/Component signals entered into the DVI port can be output. Signals from equipment connected to the DVI digital port cannot be output.

Using INPUT 1 Terminal with the Terminal Cover Attached to the Projector

The INPUT 1 terminal can be used with the terminal cover folded as shown in the illustration.

Optional cable

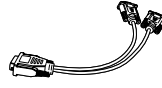

RGB monitor loop-out adaptor
Type: AN-A1MY
(7.9" (20 cm))

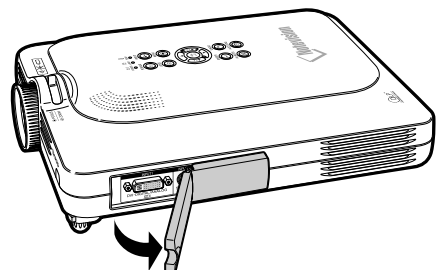
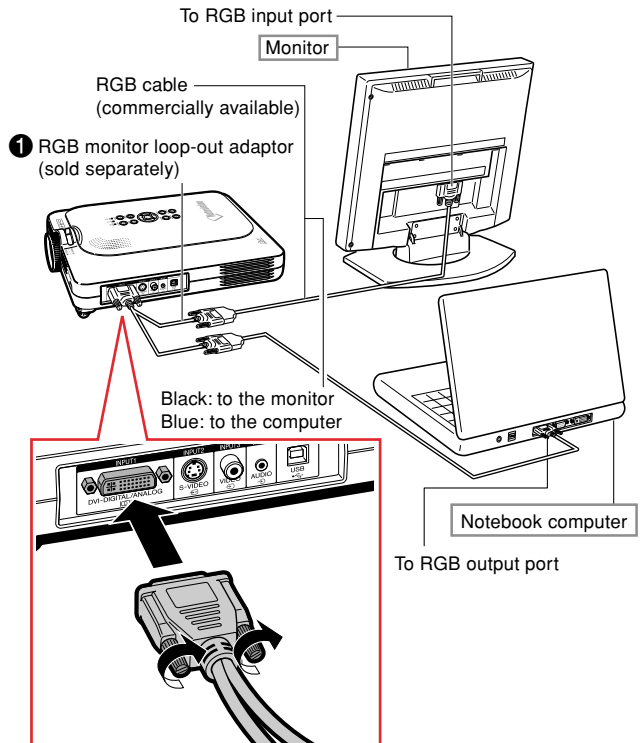

Connecting the Projector to Other Devices (cont.)

Using the Wireless Presentation Function of the Remote Control

The Wireless Presentation function on the projector works the same as the [Page Up] and [Page Down] keys on a computer keyboard. It can also be used to move forward or backward when viewing images of presentation software such as Power Point™.

Using the Wireless Presentation Function

- 1 Connect the projector to the computer using the supplied USB cable.

Note

- This function only works with Microsoft Windows OS and Mac OS. However, this function does not work with the following operating systems that do not support USB.
 - Versions earlier than Windows 95.
 - Versions earlier than Windows NT 4.0.
 - Versions earlier than Mac OS 8.5.

Supplied accessory

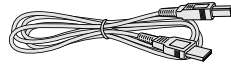

USB cable

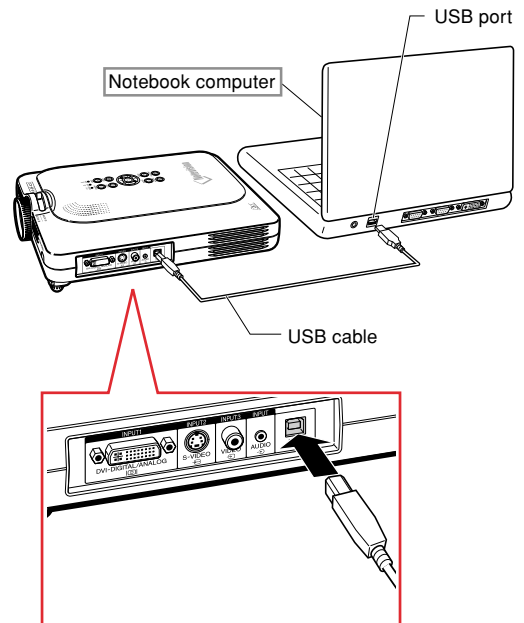

- 2 Press  while using presentation software on your computer.

- Press **FORWARD** to move the page down.
- Press **BACK** to move the page up.

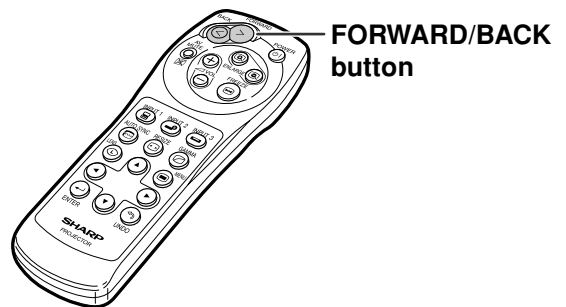

Basic Operation

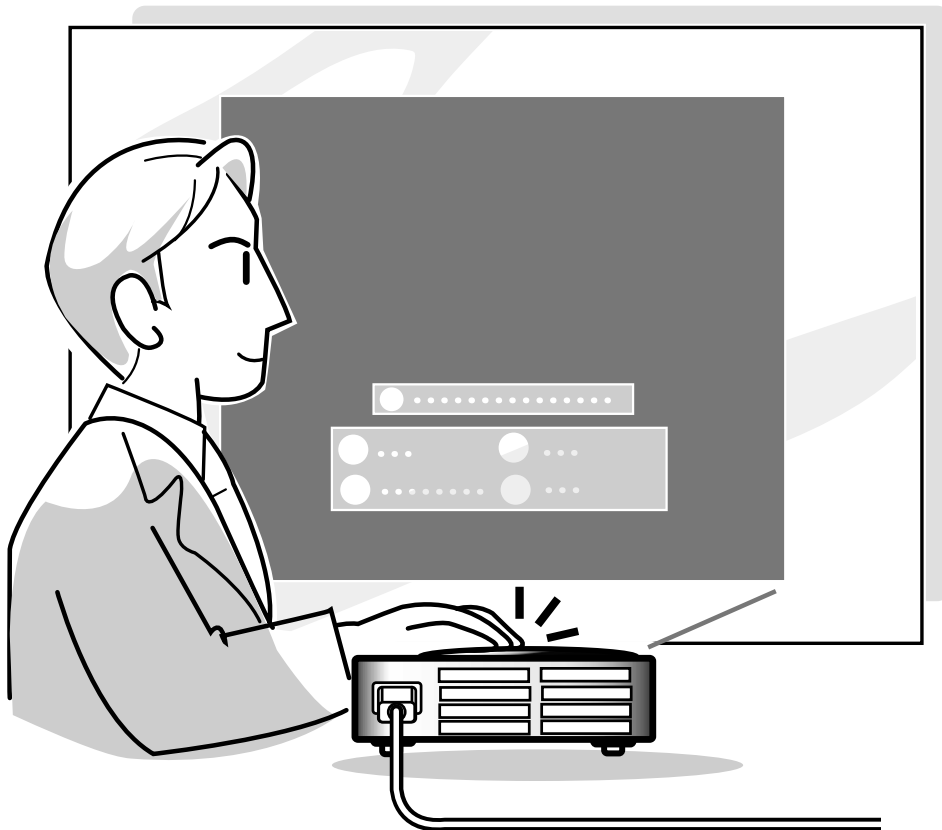

Image Projection

Basic Procedure

Connect the required external equipment to the projector before operating the following procedures.

The language preset at the factory is English. If you want to change the on-screen display to another language, reset the language according to the procedure on page 30.

1 Plug the power cord into the wall outlet.

- The POWER indicator illuminates up in red, and the projector enters standby mode.

2 Press ^{POWER} on the projector or on the remote control.

- The POWER indicator illuminates green. After the LAMP REPLACEMENT indicator illuminates, the projector is ready to start operation.

Note

- The LAMP REPLACEMENT indicator illuminates, indicating the status of the lamp.
 - Green:** The lamp is ready.
 - Green blinking:** The lamp is warming up.
 - Red:** The lamp should be replaced.
- If the power is turned off and immediately switched on again, the LAMP REPLACEMENT indicator may take time to illuminate.

When “Anti-Theft” is set, the keycode input box will appear.

- Enter the keycode.

Note

- When entering the keycode, press the buttons previously set on the projector or the remote control.

Info

- When “Anti-Theft” is set, enter the keycode or the input display will not appear. Even when the signal is input, the display will not appear.

▼Projector indicators

LAMP REPLACEMENT indicator POWER indicator

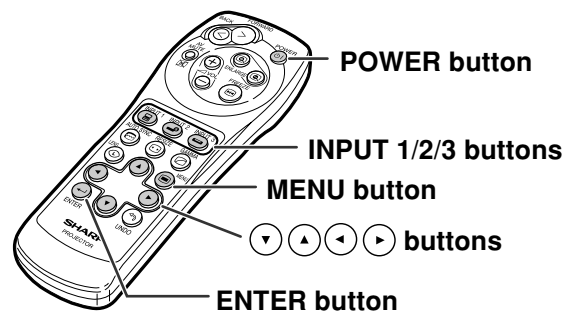
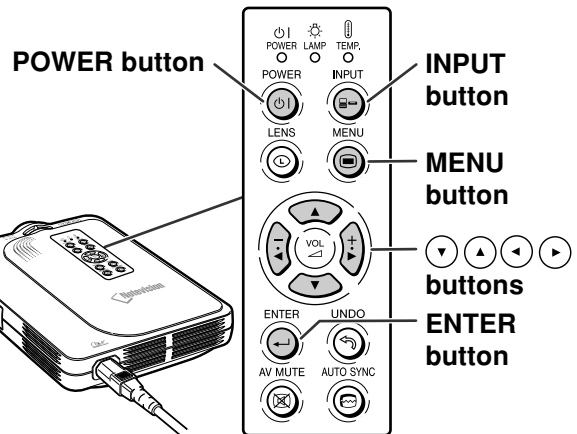
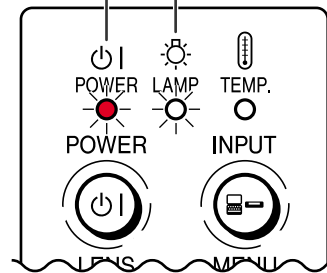

▼Keycode input box

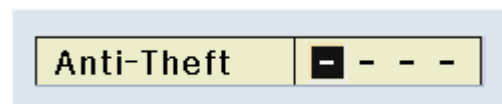

3 Press , or on the remote control to select the INPUT Mode.

- After pressing  once, use the button to select the desired INPUT Mode.

Note









- When no signal is received, "NO SIGNAL" will be displayed. When a signal that the projector is not preset to receive is received, "NOT REG." will be displayed.

About the INPUT Modes

INPUT 1 (RGB/ Component)	Used for projecting images from equipment that sends RGB signals or Component signals connected to the DVI-DIGITAL/ANALOG input port.
INPUT 2 (S-Video)	Used for projecting images from equipment connected to the S-VIDEO input terminal.
INPUT 3 (Video)	Used for projecting images from equipment connected to the VIDEO input terminal.

4 Press or on the remote control to adjust the volume of the speaker.

Note

- Pressing  will raise the volume.
Pressing  will lower the volume.
- On the projector, the volume can be adjusted by pressing  or .
- ,  on the projector operate as cursor buttons (, ) when selecting setup or adjustment functions while adjusting menus or the lens.

▼On-screen Display (Example)

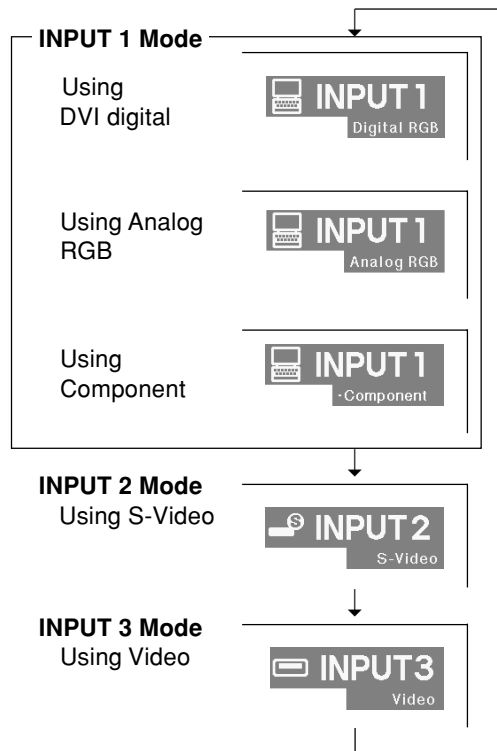





Image Projection (cont.)

5 Press  to temporarily turn off the picture and sound.

 **Note**

- Pressing  again will turn the picture and the sound back on.

6 Press , then press  again while the confirmation message is displayed, to turn off the projector.

 **Note**

- If you accidentally pressed  and do not want to turn off the power, wait until the confirmation message disappears.

 **Info**

- Do not unplug the power cord during projection or cooling fan operation. This can cause damage due to the rise in internal temperature, as the cooling fan also stops.
- When connected to equipment such as an amplifier, be sure to turn off the power to the equipment connected first and then to the projector.

Selecting the On-screen Display Language



- The on-screen display language of the projector can be set to English, German, Spanish, Dutch, French, Italian, Swedish, Portuguese, Chinese, Korean or Japanese.

1 Press  .

- The menu will be displayed.

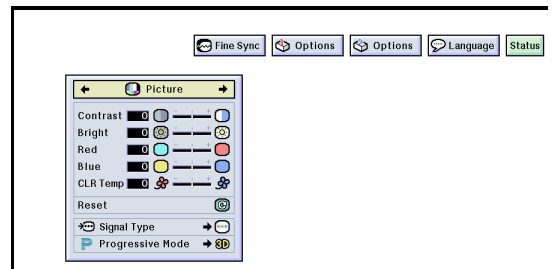
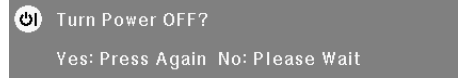
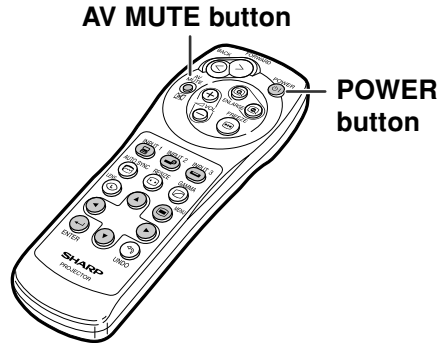
2 Press  or  to select “Language”.



3 Press  or  to select the desired language, and then press .

4 Press  .
•The desired language will be set as the on-screen display.



Adjusting the Lens

The image is focused and adjusted to the desired size using the focus ring or zoom knob on the projector.

1 The focus is adjusted by rotating the focus ring.

2 Zooming is adjusted by moving the zoom knob.

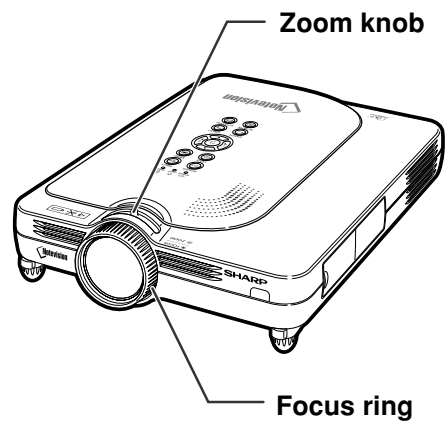

Correcting Trapezoidal Distortion (Keystone Correction)

Correcting Trapezoidal Distortion

This function allows for Keystone (On-screen Trapezoidal Distortion) Correction.





Note

- Keystone Correction is the correction for trapezoidal distortion that occurs when the image is positioned away from the center axis of the screen.
- The trapezoidal distortion can be corrected up to an angle of approximately ± 35 degrees.

1 Press .

- Pressing  again while the BORDER, STRETCH or SMART STRETCH screen is displayed will start the Digital Shift function. See page 33.

2 Press or to adjust the Keystone correction.

- If you want to make more detailed corrections, press  to display the test pattern, and then press    or  to make the adjustments.

Note

- Since the trapezoidal distortion of the image can be corrected up to an angle of approximately ± 35 degrees, the actual screen can be diagonally set up to that angle as well. (For more details on the settings, see page 8.)
- Press  to cancel Keystone Correction.

3 Press .

Note

- You can use the same settings used in NORMAL mode 4:3 for 16:9.
- Straight lines or the edges of images may appear jagged while adjusting the image.

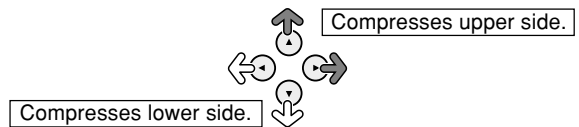
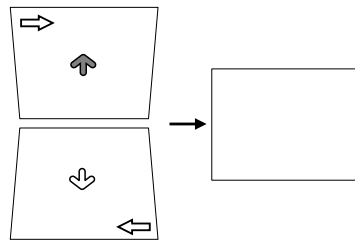
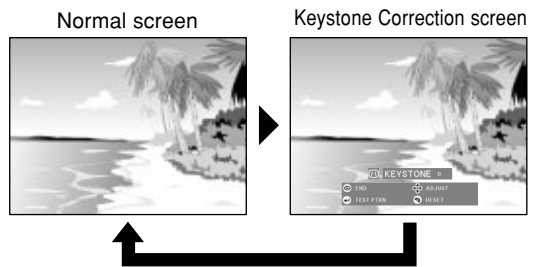
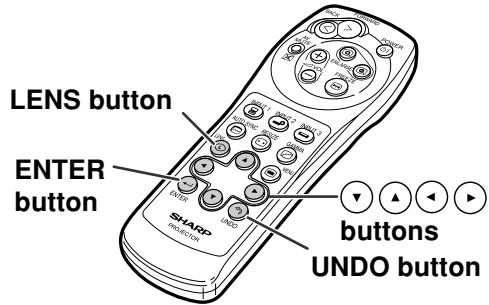

Test pattern

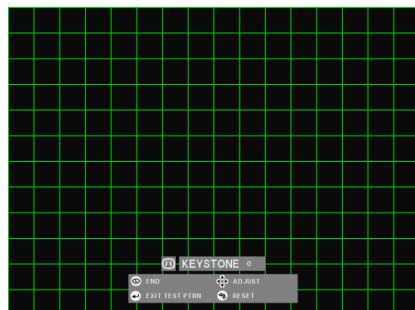

Digital Shift Setting

For easier viewing, this function shifts the entire image projected on the screen up or down when projecting 16:9 images from DVD players and DTV* decoders.

* DTV is the umbrella term used to describe the new digital television system in the United States.

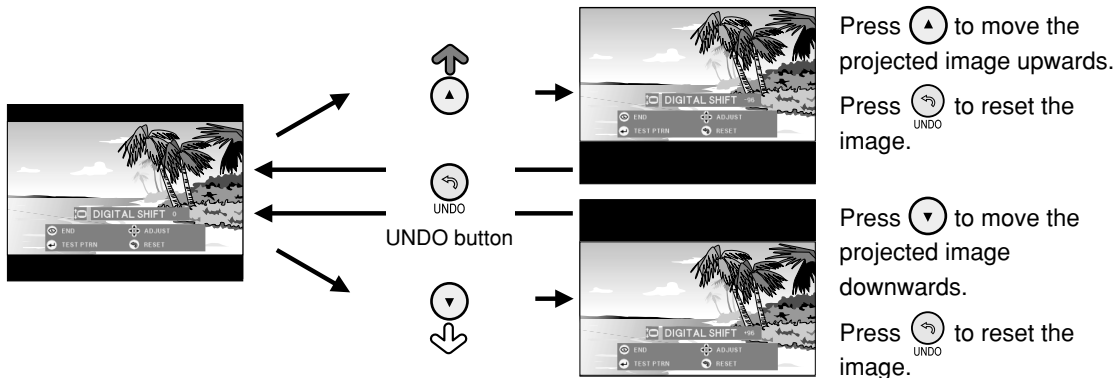

- The Digital Shift function works with BORDER, STRETCH or SMART STRETCH screen. For details, see page [47](#).

Menu Bar Items

This list shows the items that can be set in the projector.

■ INPUT 1 Mode

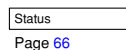
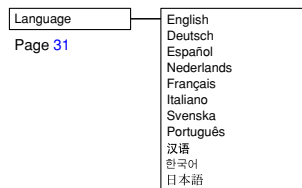
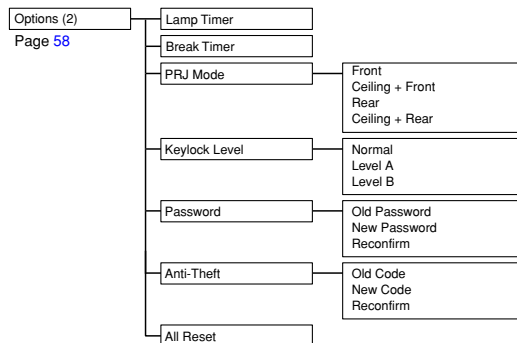
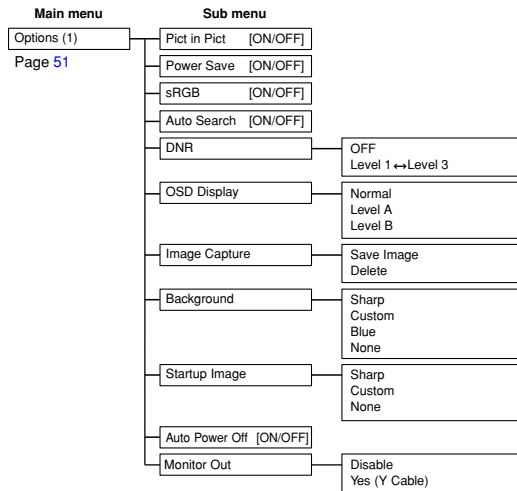
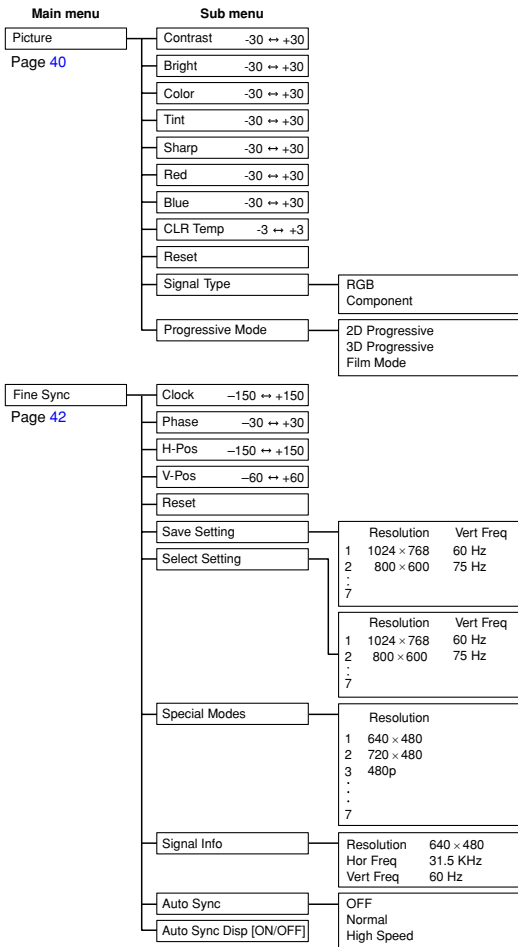

Note

- The resolution, vertical frequency and horizontal frequency figures displayed above are for example purposes only.
- When DVI digital signals have been entered into INPUT 1, in “Picture” only “CLR Temp”, “Red” and “Blue” can be adjusted and in “Fine Sync” only “Signal Info”, “Auto Sync” and “Auto Sync Disp” can be used.
- When the signal type is set as “Component”, in the “Picture” menu of INPUT 1 “Color”, “Tint” and “Sharp” are displayed.
- Some items cannot be reset, even when “All Reset” in Options (2) has been selected. For details see page 65.

■ INPUT 2 / 3 Mode

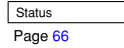
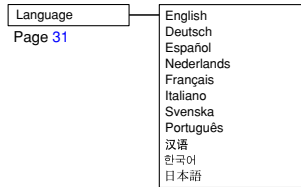
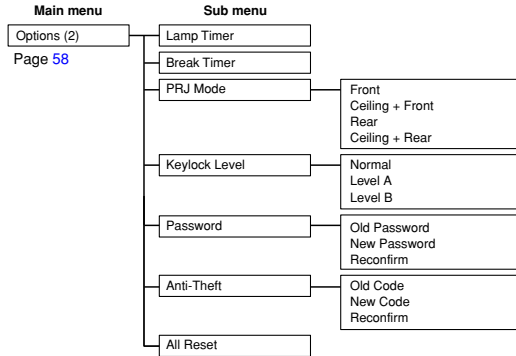
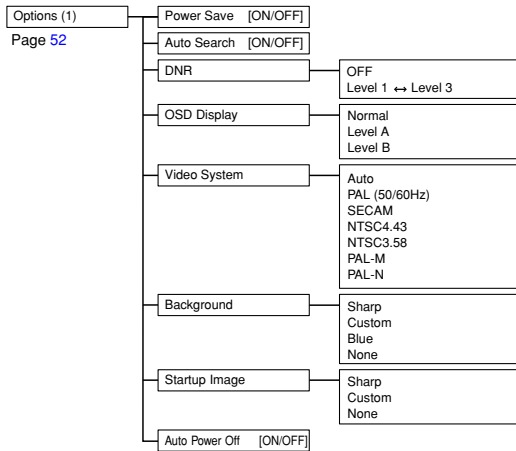
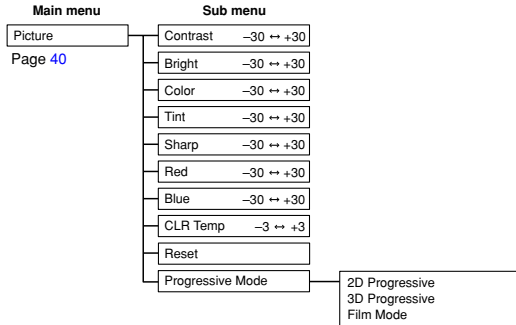

Using the Menu Screen

This projector has two sets of menu screens that allow you to adjust the image and various projector settings.

You can operate the menus from the projector or remote control using the following procedure.

On-screen menu for INPUT 1 RGB mode

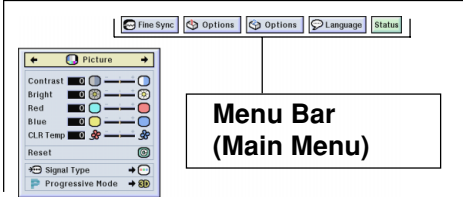

On-screen menu for INPUT 2 or INPUT 3 Mode

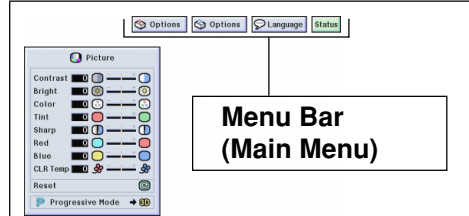

Basic Operations (Adjustments)

1 Press  .

Note

- The "Picture" menu screen for the selected input mode is displayed.
- The on-screen display shown on the right is displayed when the INPUT 1 mode is selected.

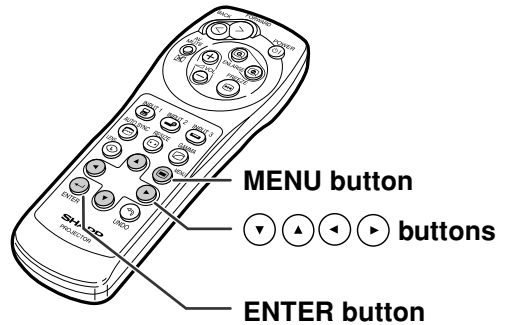
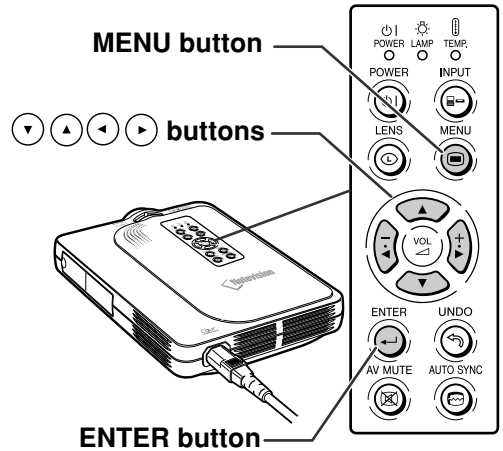

▼ On-screen Display

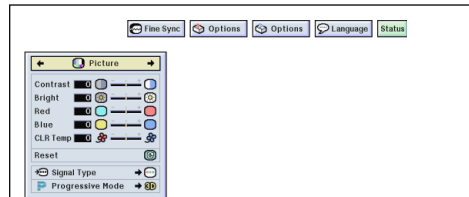

2 Press ◀ or ▶ to select the menu you want to adjust.

Note

- For details on the menus, see the tree charts on pages 34 and 35.

3 Press ▲ or ▼ to select the item you want to adjust.

Note

- To display a single adjustment item, press \leftarrow after selecting the item. Only the menu bar and the selected adjustment item will be displayed. Then if you press ▲ or ▼, the following item (“Phase” is after “Clock”) will be displayed.

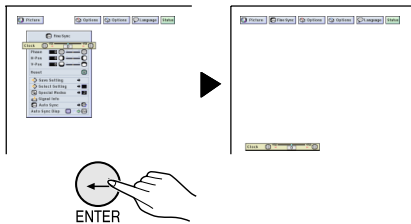

- Press \leftarrow to return to the previous screen.

4 Press ◀ or ▶ to adjust the item selected.

- When you release ◀ or ▶ the adjustment is stored.

5 Press $\left[\text{MENU} \right]$.

- The on-screen display is cleared.

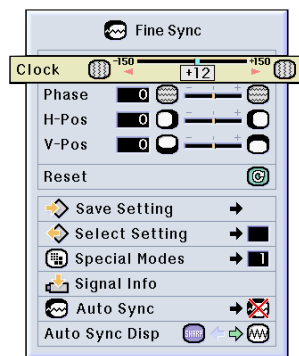
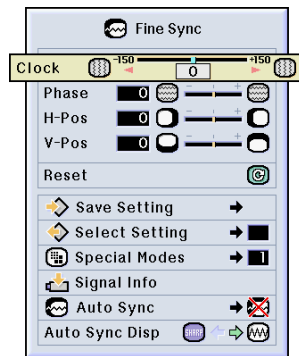
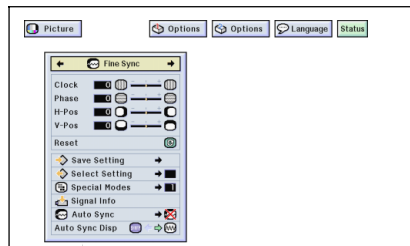

Using the Menu Screen (cont.)

Basic Operations (Settings)

1 Press  .



 **Note**

- The “Picture” menu screen for the selected input mode is displayed.
- The on-screen display shown on the right is displayed when INPUT 1 mode is selected.



2 Press  or  to select the menu you want to adjust.

 **Note**

- For details on the menus, see the tree charts on pages 34 and 35.

3 Press  or  to select the item you want to set.

 **Note**

- Press  to return to the previous screen.
- In some menus, select the icon using “”.

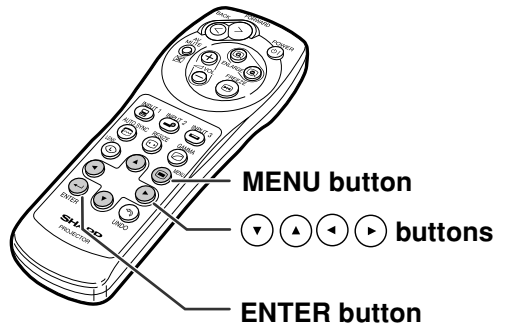
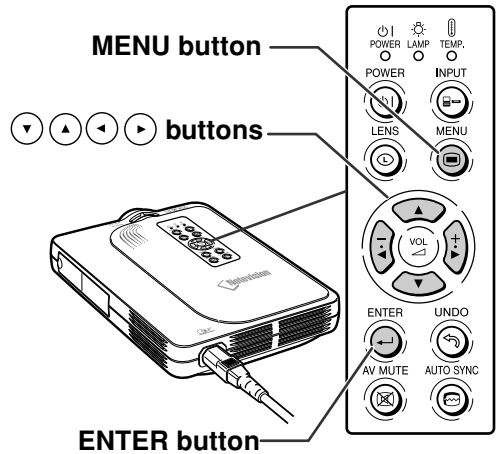

▼ On-screen Display

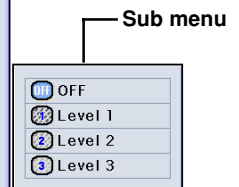
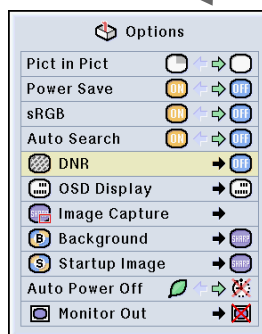
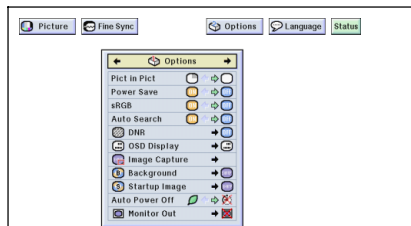
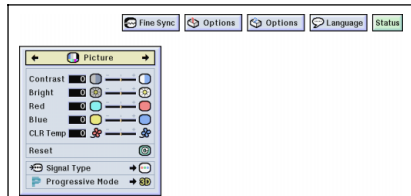

4 Press .

- The cursor shifts to the sub menu.

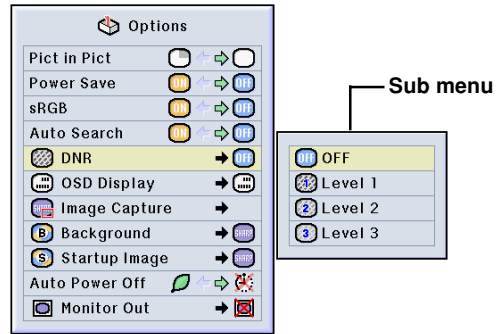

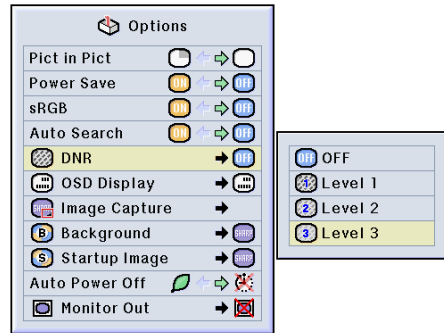

5 Press or to select the setting of the item displayed in the sub menu.



6 Press .

- The item selected is set.

Note

- Some adjustment items will display a confirmation message. When setting an item, press  or  to select "Yes" or "OK" and then press .

7 Press .

- The menu will disappear.

Adjusting the Picture

You can adjust the projector's picture to your preferences with the following picture settings.

Selected Item	Description	◀ button	▶ button
Contrast	For adjusting the contrast level	For less contrast	For more contrast
Bright	For adjusting the brightness of an image	For less brightness	For more brightness
Color	For adjusting the color intensity of the image	For less color intensity	For more color intensity
Tint	For adjusting the tones of an image	Skin tones become purplish	Skin tones become greenish
Sharp	For making sharper or softer the contour of an image	For less sharpness	For more sharpness
Red	For adjusting the redness level	For weaker red	For stronger red
Blue	For adjusting the blue level	For weaker blue	For stronger blue
CLR Temp	For adjusting the color temperature of an image	Decreases color temperature for warmer, reddish, incandescent-like images.	Increases color temperature for cooler, bluish, fluorescent-like images.



Adjusting Image Preferences

Adjust the Picture menu →
For adjustments, see page 36.

Note

- “Color”, “Tint” and “Sharp” are not displayed when selecting INPUT 1 and the “Signal Type” is “RGB”.
- The picture adjustments can be stored separately in each input mode.
- When the signal type in INPUT 1 has been set to Component, “Sharp” can be adjusted when 480I, 480P, 720P or 1080I signals are connected.
- To reset all adjustment items, select “Reset” and press .

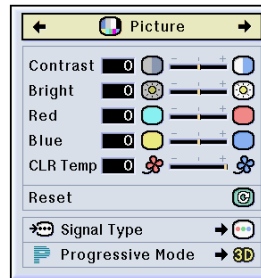

Selecting the Signal Type

This function allows you to select the input signal type RGB or Component for INPUT1.

Select “Signal Type” in the “Picture” menu → For settings, see page 38.

Note

- RGB
Set when RGB signals are received.
- Component
Set when Component signals are received.

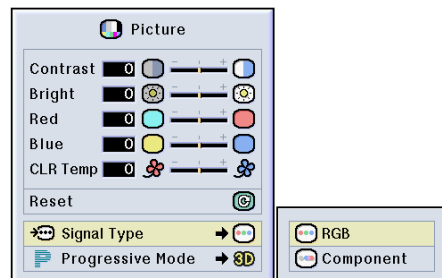

Progressive Mode

This function allows you to select the progressive display of a video signal. The progressive display projects a smoother video image.

Select “Progressive Mode” in the “Picture” menu → For settings, see page 38.

Note

- **2D** 2D Progressive

This function is useful to display fast-moving images such as sports and action films. This mode optimizes the image in a displayed frame.

- **3D** 3D Progressive

This function is useful to display relatively slow-moving images such as drama and documentary more clearly.

This mode optimizes the image by estimating the movement of a number of preceding and succeeding frames.

- **Film** Film Mode

Reproduces the image of film source clearly. Displays the optimized image of film transformed with three-two pull down (NTSC and PAL60Hz) or two-two pull down (PAL50Hz and SECAM) enhancement to progressive mode images.

* The film source is a digital video recording with the original encoded as is at 24 frames/second. The projector can convert this film source to progressive video at 60 frames/second with NTSC and PAL60Hz or at 50 frames/second with PAL50Hz and SECAM to play back a high-definition image.

- When using progressive inputs, these inputs are directly displayed therefore 2D Progressive, 3D Progressive and Film Mode cannot be selected. These modes can be selected in interlace signals other than 1080I.

- In NTSC or PAL60Hz, even if the 3D Progressive mode has been set, the three-two pull down enhancement will be enabled automatically, when the film source has been entered.

- In PAL50Hz or SECAM, the two-two pull down enhancement will be enabled only in the Film Mode, when the film source has been entered.

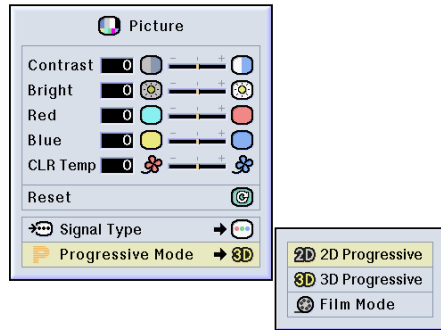

Adjusting Computer Images

Use the Fine Sync function in case of irregularities such as vertical stripes or flickering in portions of the screen.

Selected Item	Description
Clock	Adjusts vertical noise.
Phase	Adjusts horizontal noise (similar to tracking on your VCR).
H-Pos	Centers the on-screen image by moving it to the left or right.
V-Pos	Centers the on-screen image by moving it up or down.



When Auto Sync is OFF

When “Auto Sync” is “OFF”, interference such as flickering or vertical stripes may occur if displaying tilings or vertical stripes. Should this occur, adjust “Clock”, “Phase”, “H-Pos” and “V-Pos” for obtaining an optimum image.

Select “Clock”, “Phase”, “H-Pos” or “V-Pos” in the “Fine Sync” menu → For adjustments, see page 36.

Note

- Computer image adjustments can be made easily by pressing . See page 44 for details.

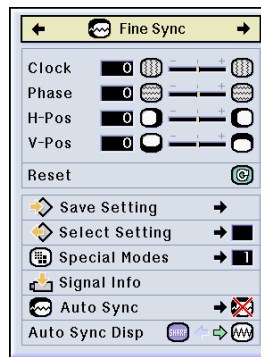

Saving Adjustment Settings

This projector allows you to store up to seven adjustment settings for use with various computers.

Select “Save Setting” in the “Fine Sync” menu → For saving, see page 38.

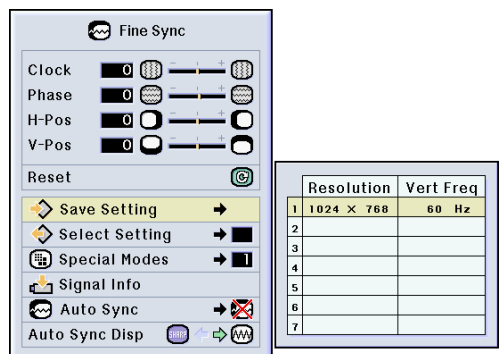

Selecting Adjustment Settings

Adjustment settings stored in the projector can be easily accessed.

Select “Select Setting” in the “Fine Sync” menu → For details, see page 38.

Note

- If a memory position has not been set, a resolution and frequency setting will not be displayed.
- When selecting a stored adjustment setting with “Select Setting”, you can set the projector in the stored adjustments.

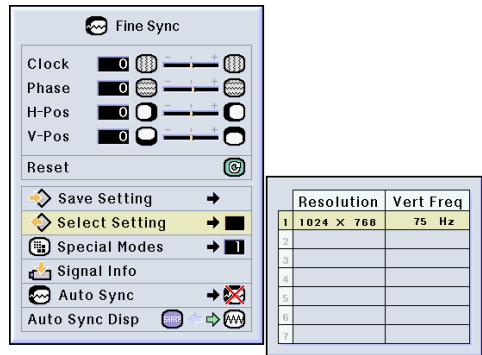

Special Mode Settings

Ordinarily, the type of input signal is detected and the correct resolution mode is automatically selected. However, for some signals, the optimal resolution mode in “Special Modes” on the “Fine Sync” menu screen may need to be selected to match the computer display mode.

Set the resolution by selecting “Special Modes” in the “Fine Sync” menu → For details, see page 38.

Note

- Avoid displaying computer patterns which repeat every other line (horizontal stripes). (Flickering may occur, making the image hard to see.)
- When a DVD player or Digital Video is connected, select 480P as the input signal.
- See “Checking the Input Signal” below for information on the currently selected input signal.

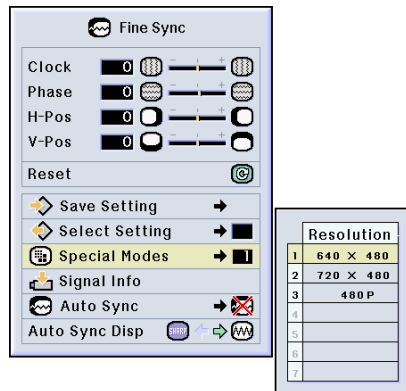

Checking the Input Signal

This function allows you to check the current input signal information.

Select “Signal Info” in the “Fine Sync” menu → For confirmation, see page 36.

Note

- The projector will display the number of scanned lines available from audio-visual equipment such as a DVD player or Digital Video.

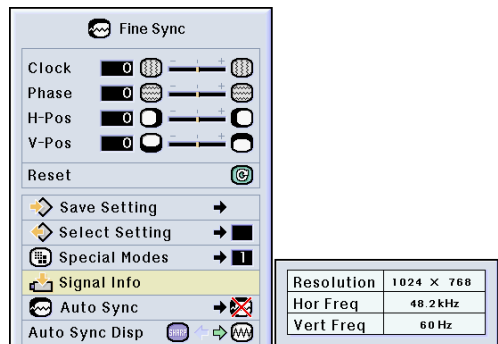

Adjusting Computer Images (cont.)

Auto Sync Adjustment

Used to automatically adjust a computer image.

Select “Auto Sync” in the “Fine Sync” menu → For settings, see page 38.

Note

When setting to “Normal” or “High Speed”:

- Auto Sync adjustment will occur when the projector is turned on or when the inputs are switched, when connected to a computer.

Manual adjustments should be performed:

- When the optimum image cannot be achieved with Auto Sync adjustment. See page 42.
- Auto Sync adjustment may take some time to complete, depending on the image of the computer connected to the projector.
- When setting “Auto Sync” to “OFF” or “High Speed”, and if  is pressed Auto Sync will be executed in “High Speed” mode. If the button is pressed again within one minute, Auto Sync will be executed in “Normal” mode.

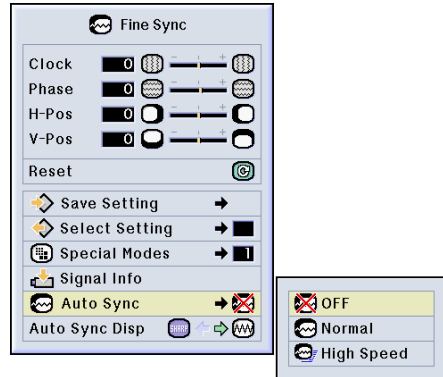

Screen display during Auto Sync



AUTO SYNC button

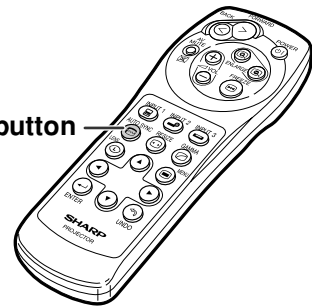



Auto Sync Display Function

Used to set the screen displayed during Auto Sync.

Select “Auto Sync Disp” in the “Fine Sync” menu → For settings, see page 36.

Note

- .....The image set as a background image is projected.
- .....The computer image being adjusted is displayed.

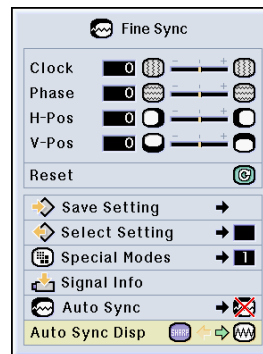



Easy to Use Functions



Selecting the Picture Display Mode

This function allows you to modify or customize the picture display mode to enhance the input image. Depending on the input signal, you can choose “NORMAL”, “FULL”, “DOT BY DOT”, “BORDER”, “STRETCH” or “SMART STRETCH” image.

Switching the Picture Display Using Different Input Signals

- 1** Press  **RESIZE**
- Each time  is pressed, the display changes as shown on page 47.

Note

- In the Dot by Dot Mode, images are displayed in the original resolution, therefore they will not be enlarged.
- To return to the standard image, press  while “RESIZE” is displayed on the screen.





Screen display of the picture display mode



COMPUTER

		NORMAL	FULL	DOT BY DOT
4:3 aspect ratio	SVGA (800 × 600)	800 × 600	—	—
	XGA (1024 × 768)	800 × 600	—	1024 × 768
	SXGA (1280 × 960)	800 × 600	—	1280 × 960
Other aspect ratios	SXGA (1280 × 1024)	750 × 600	800 × 600	1280 × 1024

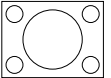
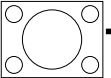
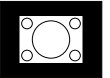
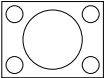
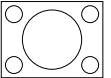
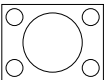
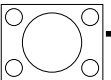
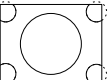
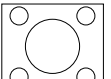
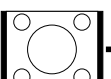
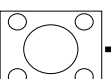



- “NORMAL” is fixed when SVGA (800 × 600) signals are entered.

Input Signal		Output screen image		
		NORMAL Projects a full screen image while maintaining the aspect ratio.	FULL Projects a full screen image while ignoring the aspect ratio.	DOT BY DOT Projects the original resolution signal of the image.
Resolution lower than SVGA	 4:3 aspect ratio		—	
SVGA	 4:3 aspect ratio		—	—
Resolution higher than SVGA	 4:3 aspect ratio		—	
SXGA (1280 × 1024)				

VIDEO

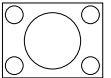
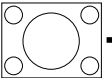
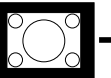
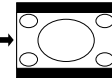
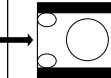
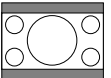
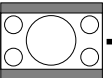
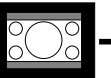
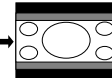
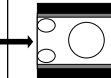
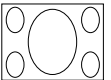
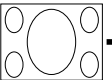
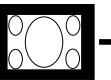
		NORMAL	BORDER	STRETCH	SMART STRETCH
480I, 480P, NTSC PAL, SECAM	4:3 aspect ratio. Letter box, squeeze	800 × 600	600 × 450*	800 × 450*	800 × 450*
720P, 1080I	16:9 aspect ratio	—	—		—

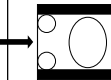
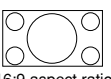
- “STRETCH” is fixed when 720P or 1080I signals are entered.
- * The Digital Shift function can be used with these images.

Input Signal		Output screen image			
		NORMAL Projects a full screen image.	BORDER Projects 4:3 image fully in STRETCH (the following column) image.	STRETCH Projects 16:9 image evenly over entire screen (top/bottom black bands).	SMART STRETCH Projects the image fully in a 16:9 screen by enlarging only the surrounding areas while keeping the aspect ratio in the middle part of the image at 4:3.
480I, 480P, NTSC, PAL, SECAM	 4:3 aspect ratio				
	 Letter box				
	 Squeeze				
720P, 1080I	 16:9 aspect ratio	—	—		—

Displaying a Still Image

This function allows you to instantly **freeze** a moving image. This is useful when you want to display a still image from a computer or video, giving you more time to explain the image to the audience.

Storing an Image in Still Image Format

- 1** Press .
 - The projected image is frozen.

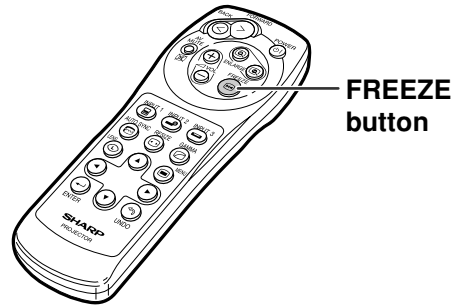

▼ On-screen Display

FREEZE ON

FREEZE OFF



- 2** Press  again to return to the moving image from the currently connected device.

Enlarging a Specific Portion of an Image

This function allows you to enlarge a specific portion of an image. This is useful when you want to display a detailed portion of the image.





Displaying an Enlarged Portion of an Image

1 Press .

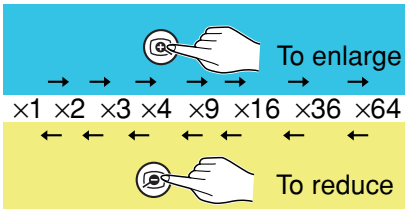
- Enlarges the image.
- Pressing  or  enlarges or reduces the projected image.

Note



- You can change the location of the enlarged image using , ,  or .
- When an image with a resolution higher than XGA is displayed, “x2” and “x3” cannot be selected.

2 Press to cancel the operation, then the magnification returns to x1.

Note

- In the following cases, the image will return to the normal size (x1).
- When the input mode is changed.
 - When  has been pressed.
 - When the input signal is changed.
 - When the input signal resolution and refresh rate (vertical frequency) change.

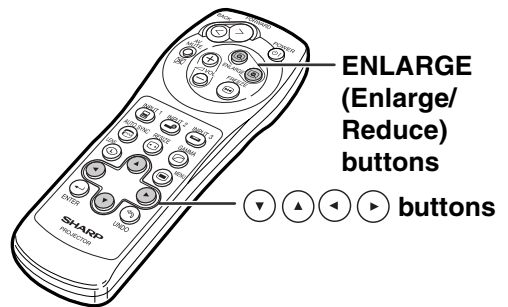

▼ On-screen Display

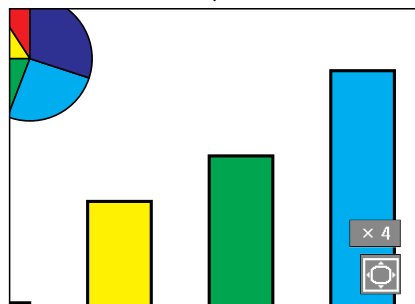
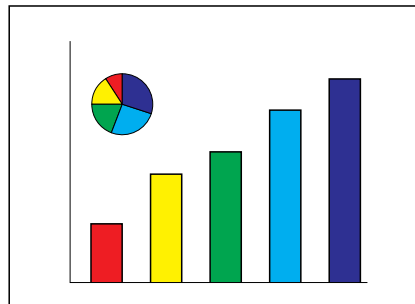



Gamma Correction Function

Gamma is an image quality enhancement function that offers a richer image by brightening the darker portions of the image without altering the brightness of the brighter portions. When you are displaying images with frequent dark scenes, such as a film or concert, or when you are displaying images in a bright room, this feature makes the dark scenes easier to see and gives the impression of greater depth in the image.

Selected Mode	Description
STANDARD	For Standard picture
PRESENTATION	Brightens darker portions of image for more enhanced presentations.
CINEMA	Gives greater depth to darker portions of image for a more exciting theater experience.
GAME	Natural color gradation for playing a game, etc.

Adjusting Gamma Correction

- Press .

 - Each time  is pressed, the gamma level toggles between the different types of gamma modes.

- Depending on the input mode and signal, pressing  while "GAMMA" is displayed will return you to the respective gamma mode.

INPUT mode	INPUT signal	GAMMA mode
INPUT1	RGB	PRESENTATION
	Component	CINEMA
INPUT2	S-Video	STANDARD
INPUT3	Video	STANDARD

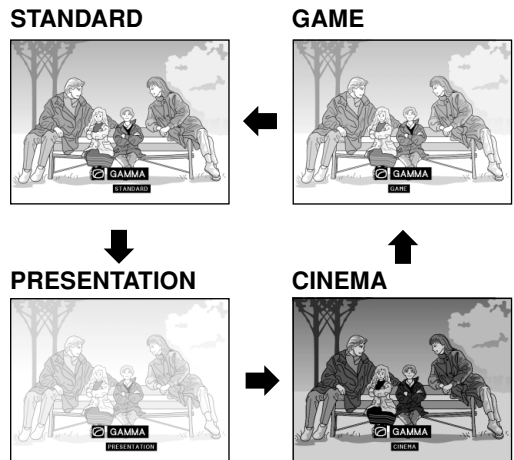
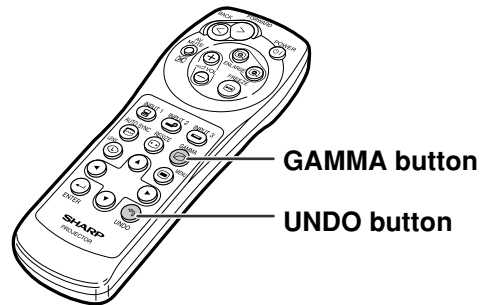

Displaying Dual Pictures (Pict in Pict)

Picture in Picture function allows you to display two pictures on the same screen. You can display the image input from INPUT 2 or 3 as an inset picture overlapping the main picture from INPUT 1. (This function can only be set in the RGB menu.)

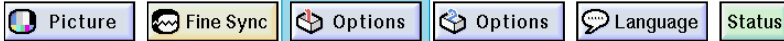

Displaying the Inset Picture

Select "Pict in Pict" in the "Options (1)" menu → For displaying, see page 36.

1 Press to select .
 • Select to clear the Pict in Pict mode.

2 Press or on the remote control or on the projector to switch the image in the inset picture.

3 Press , , or to set the position of the inset picture.
 • Press to stop the frame from moving or to make the frame disappear.

4 Press to move the inset picture.
 • The inset picture will be moved to the inset picture frame.

Note

- The inset picture can only be displayed with composite video (NTSC/PAL/SECAM) or S-Video signal.
- The Freeze function works only with the inset picture, when the Pict in Pict mode is in operation.

When the signal entered into INPUT 1 is as follows, Pict in Pict does not work:

- With a resolution that overexceeds SXGA.
- When the input signal is 480I, 480P, 720P or 1080I.
- When the input signal has changed to the Interlace mode using RGB signals.
- When the picture display mode is set to "DOT BY DOT".
- When no signals are sent to INPUT 1, or when the resolution or refresh rate (vertical frequency) is changed.
- Press or on the remote control or on the projector to switch the image in the inset picture.

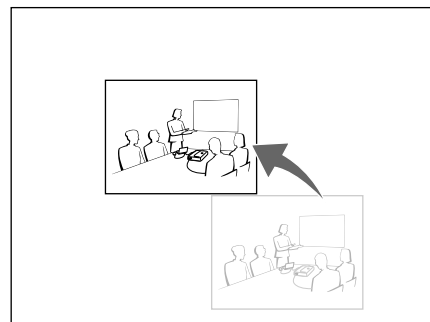
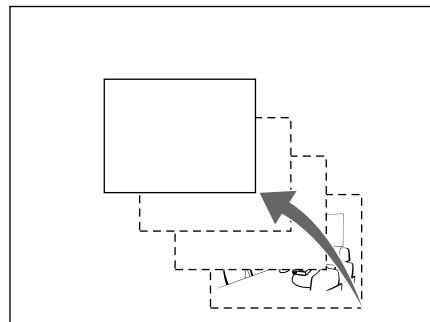
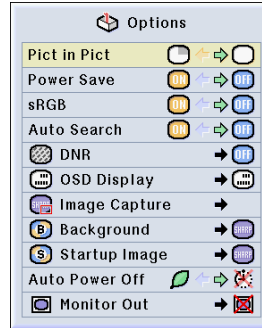

Selecting the Power Save Mode

The Power Save Mode or the Automatic Power Shutoff function allows you to reduce the power consumption of the projector.



Setting the Power Save Mode

Function to control the quantity of projected light. Select "ON" or "OFF" to decrease or increase brightness and power consumption.

Description of Power Save Modes

ON	Quantity of light is 80%. Power consumption is 250W.
OFF	Quantity of light is 100%. Power consumption is 290W.

Select "Power Save" in the "Options (1)" menu → For settings, see page 36.

Note

- "Power Save" mode is factory preset to "OFF".

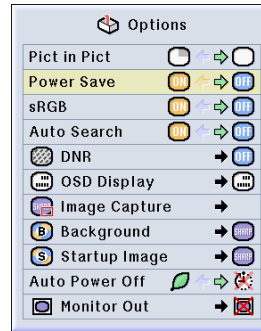

Automatic Power Shutoff Function

When no input signal is detected for more than 15 minutes, the projector will automatically shut off if set to "On".

The Auto Power Off function will be disabled when it has been set to "Off".

Select "Auto Power Off" in the "Options (1)" menu → For settings, see page 36.

Note

- When the Auto Power Off function is set to "On", 5 minutes before the power turns off, the message "Power OFF in X min." will appear on the screen to indicate the remaining minutes.

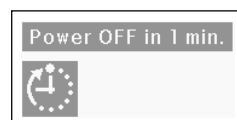

Activating the sRGB Color Management Function

This function calibrates the projector's output to conform to sRGB standard (6,500K).

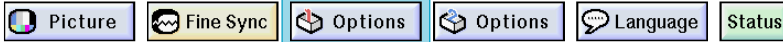

Setting the Color Management Function (sRGB)

Select "sRGB" in the "Options (1)" menu
→ For settings, see page 36.

Note

- When setting sRGB to "ON", the projected image may become dark; however, this does not indicate a malfunction.
- For additional information about sRGB function, please visit "<http://www.srgb.com/>".

Info

- When "sRGB" is set to "ON";
- The gamma correction cannot be set.
 - "Red", "Blue" or "CLR Temp" in "Picture" cannot be adjusted.

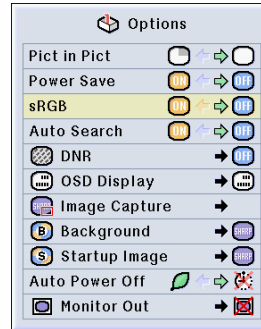







Auto Search Function

This function automatically searches for and switches to the input mode in which signals are being received, when the projector is turned on, or when the INPUT button is pressed.







Using Auto Search

Select "Auto Search" in the "Options (1)" menu → For settings, see page 36.

Note

- **ON** ON
Automatically switches to the input mode in which signals are being received, when turning on the projector or pressing  on the projector.
- **OFF** OFF
For switching input modes manually in order by pressing  on the projector.
- To stop searching for the input mode, press  on the projector, or ,  or  on the remote control.

Info

- Even while this function is searching for input signals, whenever ,  or  on the remote control is pressed, the input mode is switched to the respective one.
- Even while the function is searching for input signals, pressing any buttons besides ,  and  returns to the previous input mode.

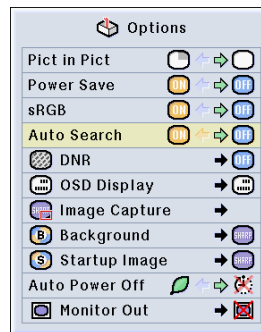

Video Digital Noise Reduction (DNR) System

Digital Noise Reduction (DNR) provides high quality images with minimal dot crawl and cross color noise.



Reducing Image Noise (DNR)

Select “DNR” in the “Options (1)” menu → For settings, see page 38.

Note

- Set a level so as to view a clearer picture.
- Make sure to set DNR to “OFF” in the following cases:
- When the image is blurry.
 - When the contours and colors of moving images drag.
 - When TV broadcasts with weak signals are projected.

Info

- This function is available with INPUT 1 (480I and 480P signals) and INPUT 2, 3 (all signals).

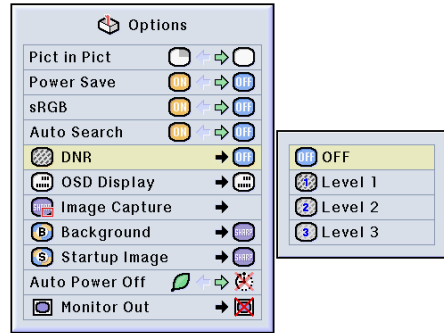

Setting the On-screen Display

This function allows you to turn on or off the on-screen messages. When setting “ Level A” or “ Level B” in “OSD Display”, the input mode display (e.g. INPUT 1) will not appear, even if the INPUT button is pressed.

Selected Item	Description
<input checked="" type="radio"/> Normal	All On-screen Displays are displayed.
<input type="radio"/> Level A	Input/Freeze/Enlarge/Auto Sync/Volume/AV Mute are not displayed.
<input type="radio"/> Level B	All On-screen Displays are not displayed. (except Menu, On-screen displays displayed when the LENS button is pressed and warning displays (Power off/Temp./Lamp, etc.))

Turning Off the On-screen Display

Select “OSD Display” in the “Options (1)” menu → For settings, see page 38.

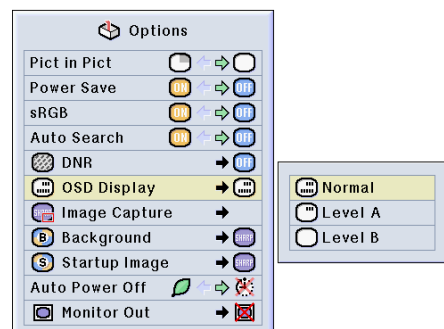

Setting the Video System

The video input system mode is preset to “Auto”; however, a clear picture from the connected audio-visual equipment may not be received, depending on the video signal difference. In that case, switch the video signal.



Setting the Video System

Select “Video System” in the “Options (1)” menu → For settings, see page 38.

Note

- The video signal can only be set in INPUT 2 or INPUT 3 mode.
- In “Auto”, images are displayed in PAL even if PAL-N or PAL-M input signals are received.

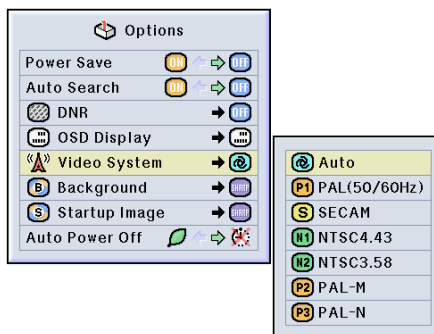

PAL	When connected to PAL video equipment.
SECAM	When connected to SECAM video equipment.
NTSC4.43	When reproducing NTSC signals in PAL video equipment.
NTSC3.58	When connected to NTSC video equipment.





Saving Projected Images



- This projector allows you to capture projected images (RGB signals) and set them as a startup image, or background image when no signals are being received.
- You can capture the images that are input using analog RGB signals and Digital DVI SVGA signals.



Capturing the Image

Select “Image Capture” in the “Options (1)” menu → For details, see page 38.

- 1 Press  or  to select “ Save Image” and press .
 - The projected image is captured. It may take some time for capturing.

- 2
 - ① Press  or  to select “Yes”.
 - ② Press .



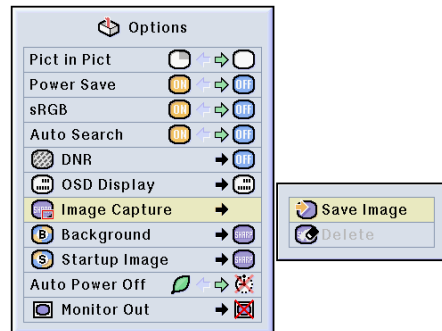

Note

- This function only works in 800 x 600 (SVGA) non-interlace mode.
- The saved image is reduced to 256 colors.
- Images from equipment connected to INPUT 2 or INPUT 3 cannot be captured.



Do you want to save this image as a custom image in the projector?
(Previously saved custom image will be deleted.)

Deleting the Captured Image

- 1 Select “ Delete” and press .
- 2
 - ① Press  or  to select “OK”.
 - ② Press .

This custom image saved in the projector will be deleted.

Setting a Background Image

This function allows you to select the image displayed when no signal is being sent to the projector.

Selected Item	Description
Sharp	SHARP default image
Custom *1	User customized image (i.e. company logo)
Blue	Blue screen
None	Black screen *2

*1 You can set a captured image as a background image by selecting “Custom”.

*2 If the input signal has interference, the screen will be displayed with the interference.



Selecting a Background Image

Select “Background” in the “Options (1)” menu → For settings, see page 38.

Note

- When “Custom” is selected, an image saved using “Image Capture” can be displayed as a background image.
- A “Custom” image is preset as a black screen.

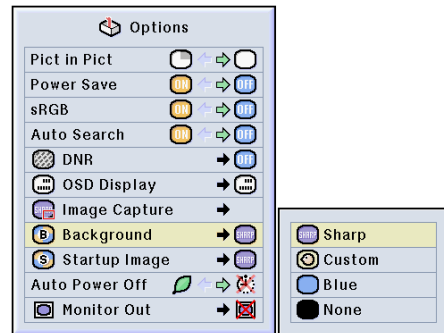

Selecting a Startup Image

This function allows you to specify the image to be displayed upon the projector’s startup.

Selected Item	Description
Sharp	SHARP default image
Custom *	User customized image (i.e. company logo)
None	Black screen

* You can set a captured image as a startup image by selecting “Custom”.

Selecting a Startup Image

Select “Startup Image” in the “Options (1)” menu → For settings, see page 38.

Note

- When “Custom” is selected, an image saved using “Image Capture” can be displayed as a startup image.
- A “Custom” image is preset as a black screen.

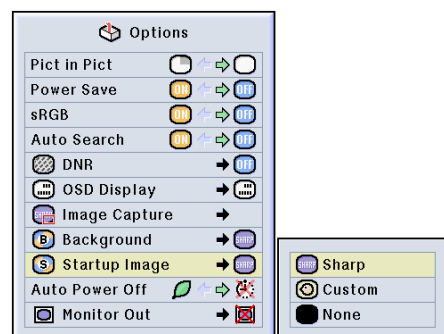

Using an RGB Monitor Loop-out Adaptor



Using an RGB monitor loop-out adaptor (sold separately) and an RGB cable (commercially available), be sure to set to “ Yes (Y Cable)” when you want to display computer images both on the projector and on a monitor.



Using a RGB Monitor Loop-out Adaptor

Select “Monitor Out” in the “Options (1)” menu → For settings, see page 38.

Note

- Be sure to set to “ Disable” when not using an RGB monitor loop-out adaptor.
- If the setting is not correct, the image may be dark, too bright or whitish. This does not indicate malfunction.
- Make sure to set to “ Yes (Y Cable)” when using the RGB monitor loop-out adaptor.

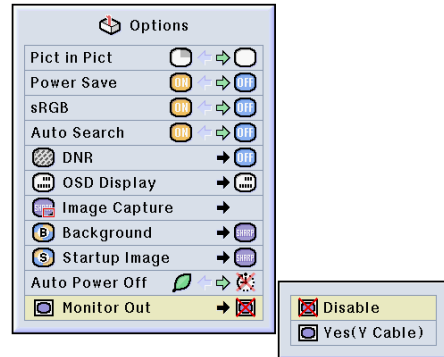

Displaying the Lamp Usage Time



Confirming the Lamp Usage Time

This function allows you to check the lamp usage time.

Select “Options (2)” menu to see the lamp usage time.

Note

- It is recommended that the lamp be changed after approximately 1,900 cumulative hours of use.
For lamp replacement, contact your nearest Sharp Authorized Projector Dealer or Service Center.

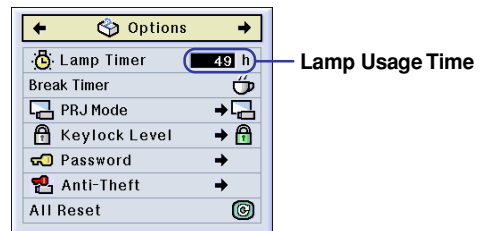

Displaying the Break Timer



Displaying and Setting the Break Timer

Select “Break Timer” from the “Options (2)” menu → For details, see page 36.

1 When “☕” is displayed, press or to set the Break Timer.

- You can set anywhere between 1 and 60 minutes (in 1 minute units).

2 Press to cancel the Break Timer.

Note

- Auto Power Off will be temporarily disabled during the Break Timer. If no signal transmission occurs for more than 15 minutes after the Break Timer has completed, the projector will turn off.
- The Break Timer will be displayed on the startup image. To change the screen displayed during the Break Timer, change the setting of “Startup Image” (see page 57).



▼ On-screen Display



Reversing/Inverting Projected Images

This projector is equipped with a reverse/invert image function that allows you to reverse or invert the projected image for various applications.

Selected Item	Description
Front	Normal image
Ceiling + Front	Inverted image
Rear	Reversed image
Ceiling + Rear	Reversed and inverted image



Setting the Projection Mode

Select “PRJ Mode” in the “Options (2)” menu → For settings, see page 38.

Note

- If a password has been set, the password input box will be displayed when selecting the “PRJ Mode”.
- This function is used for the reversed image and ceiling-mount setups. See page 19 for these setups.

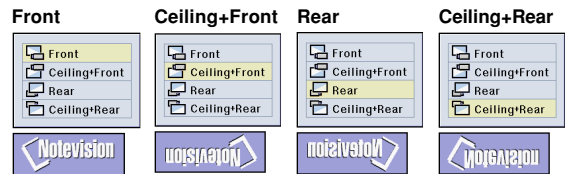
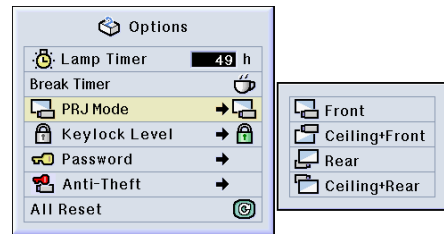

Locking the Operation Buttons on the Projector

This function can be used to lock the use of certain operation buttons on the projector. The following are the three **keylock levels**.

Keylock Level	Description
Normal	All operation buttons are functional.
Level A	Only INPUT/VOLUME/AV MUTE buttons on the projector are available.
Level B	All operation buttons on the projector are unavailable.

Setting up the Keylock

Select “Keylock Level” in the “Options (2)” menu → For settings, see page 38.

Note

- If a password has been set, the password input box will be displayed when selecting the “Keylock Level”.

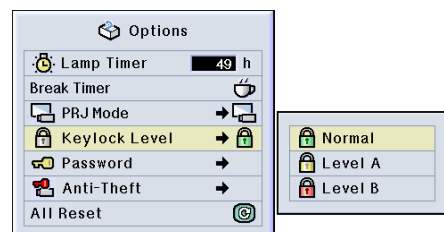

Canceling the Keylock Setting

When the Keylock Level is set to “Normal”, all buttons are functional.

Select “Keylock Level” in the “Options (2)” menu and set “Normal”. → For settings, see page 38.

Note

- When a password has been set, and “Keylock Level” is selected, the password input box will be displayed.
- If both a password and the Keylock Level have been set at the same time, the password will be necessary before changing the Keylock Level.

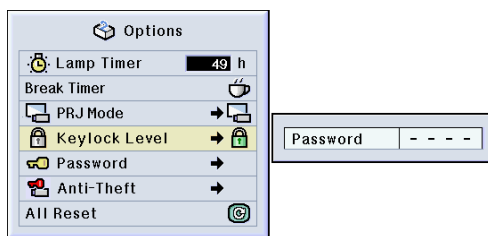

Setting up a Password

A password can be set by the user to prevent adjustments to certain settings on the “Options (2)” menu. Using a password together with the Keylock Level (page 60) is more effective.



Entering the Password

Select “Password” in the “Options (2)” menu → For details, see page 38.

1 Press or to select the desired number and then press .

2 Enter the 3 remaining digits and press .

3 Enter the password again in “Reconfirm” and press .

Note

- When a password is set, you need to enter the password to change “PRJ Mode”, “Keylock Level”, “Anti-Theft” and “All Reset” settings.

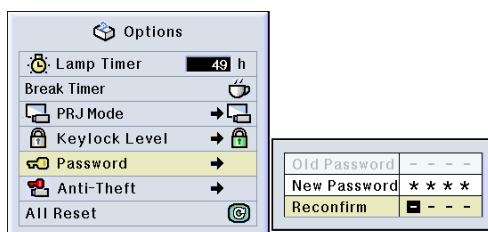
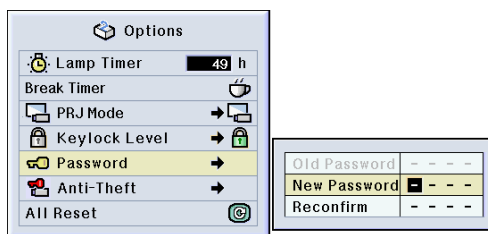

Setting up a Password (cont.)

Changing the Password

Select "Password" in the "Options (2)" menu → For selecting, see page 38.

1 Press , and to enter the password in "Old Password" and press .

2 Press , and to set the new password and press .

3 Enter the new 4-digit password again in "Reconfirm" and press .

Note

- If you do not want to set a password, leave the fields in procedures 2 and 3 blank and press .
- To cancel the password settings, click .

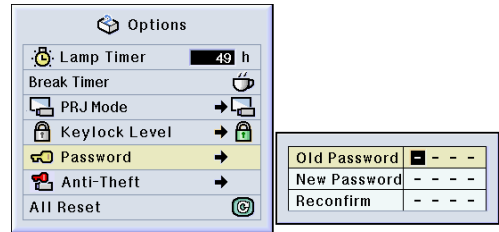

If You Forget Your Password

If you forget the password, delete it and set a new password using the following procedure.

1 Press → → → → → → .

Setting the Anti-Theft

The anti-theft function prevents unauthorized use of the projector. You can choose to use this function or not. If you do not want to use this function, just do not enter the keycode. Once the theft-deterrent function is activated, users will need to enter the correct keycode each time the projector is started. Failure to enter the correct keycode will prevent images from being projected. The following procedures explain how to use this function.



Entering the Keycode

- “Anti-Theft” cannot be selected unless “Password” is set. (See page 61.)
- When “Anti-Theft” is selected, the password input box will appear. Enter the keycode after the right password is entered.

Select “Anti-Theft” in the “Options (2)” menu → For details, see page 38.

1 Press any button you like on the remote control or projector to set the first digit in “New Code”.

Note

- The following buttons on the remote control and projector cannot be set as keycodes:
 - POWER button
 - ENTER button
 - UNDO button
 - MENU button
 - FORWARD button
 - BACK button

2 Enter the remaining 3 digits by pressing any buttons you like.

3 Enter the same keycode once more in “Reconfirm”.

Note

- The Keylock function will become temporarily disabled.

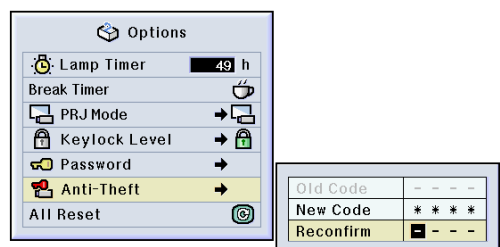
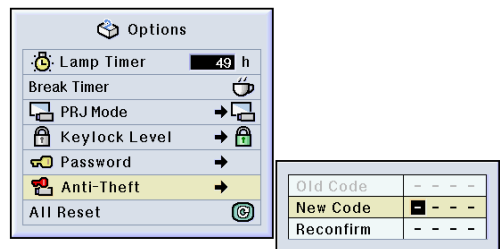
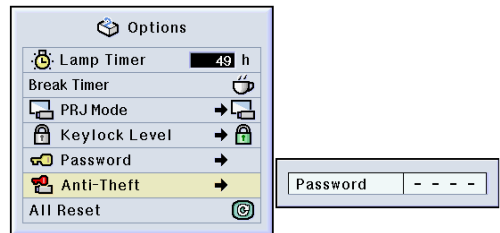

Setting the Anti-Theft (cont.)

When “Anti-Theft” is set, the keycode inputting section appears after the power is turned on. At that time, enter the right keycode.

- Press the buttons on the remote control if the buttons on the remote control are used for setting the keycode. In the same manner, press the buttons on the projector if the buttons on the projector are used for setting the keycode.

Info

- Once the function is activated, you must remember the correct keycode. We suggest you record the keycode in a safe place where only authorized users will have access. If you lose or forget your keycode, you will need to contact your nearest Sharp Authorized Projector Dealer or Service Center (see page 78). You may need to bring your projector to them to restore the projector to original factory condition (password and keycode reset).

Changing the Keycode

- When “Anti-Theft” is selected, the password input box is displayed. After the password has been entered, you can change the keycode.

Select “Anti-Theft” in the “Options (2)” menu → For details, see page 38.

1 Press the buttons on the remote control or the projector to enter the preset 4-digit keycode in “Old Code”.

2 Press any button you like on the remote control or the projector to enter the new keycode.

3 Enter the same 4-digit keycode in “Reconfirm”.

Note

- If you do not want to set a keycode, leave the keycode field blank in steps 2 and 3 and press .

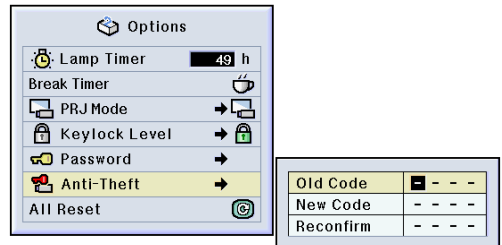

Initializing the Settings

This function allows you to initialize the settings you have made in the projector.



Returning to the Default Settings

Select “All Reset” in the “Options (2)” menu → For resetting, see page 36.

Note

- If a password has been set, the password input box will be displayed when selecting “All Reset”.

The following items cannot be initialized.

- Fine Sync
 - Special Modes
 - Signal Info
- Options
 - Lamp Timer
 - Anti-Theft
- Language
- Image stored using “Image Capture”



Displaying the Adjustment Settings

This function can be used to display all the adjusted settings as a list on the screen.



Overview of All Menu Setting

Select the “**Status**” menu and press  ENTER
 → For details, see page 36.

Picture	Fine Sync	Options	Options	Other
Contrast 0	Clock 0	Pict in Pict	Lamp Timer 49h	Language English
Bright 0	Phase 0	Power Save	PRJ Mode	
Red 0	H-Pos 0	sRGB	Keylock Level	
Blue 0	V-Pos 0	Auto Search	Password	Standard Gamma
CLR Temp 0	Select Setting	DNR	Anti-Theft	Normal Resize
Signal Type	Special Modes 1	OSD Display		
Progressive Mode	Auto Sync	Background		
	Auto Sync Disp	Startup Image		Serial Number 123456789
		Auto Power Off	Monitor Out	Firmware M20SXXXX

Appendix



Carrying the Projector

How to Use the Carrying Case

When carrying the projector, attach the lens cap to the lens, and place it in the included carrying case.

1 Open the cover of the carrying case.

2 Remove the inner padding from the carrying case, and fold it in the direction of the arrows.

3 Reinsert the inner padding into the carrying case.

Info

- Be sure to insert the inner padding to protect the lens and the projector.

4 Place the projector and the accessories in the carrying case.

Info

- Be sure to attach the lens cap to protect the lens.
- Be sure the projector has cooled down enough before placing it in the case.

Info

- This carrying case is only for storing and carrying the projector.
- Sending the projector in the carrying case as a parcel may cause damage to the projector. If you send the projector in the carrying case as a parcel, be sure to place it in a sturdy case and with enough shock absorbing material to avoid any damage.
- Do not expose the carrying case or projector to direct sunlight, near heat sources, or leave them in a car. The carrying case or projector may change color or become deformed.

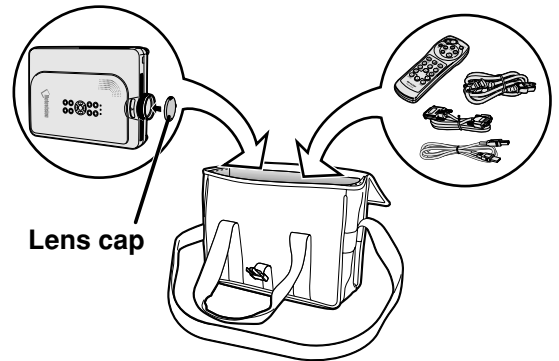
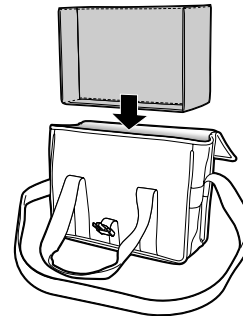
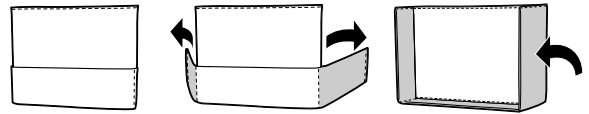
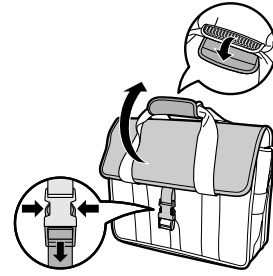

Adjust the shoulder strap.

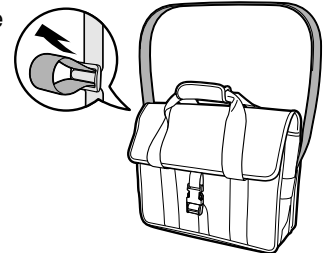

Maintenance

Cleaning the projector

- Be sure to unplug the power cord before cleaning the projector.
- The cabinet as well as the operation panel is made of plastic. Avoid using benzene or thinner, as these can damage the finish on the cabinet.
- Do not use volatile agents such as insecticides on the projector.

Do not attach rubber or plastic items on the projector for long time.

The effects of some of the agents in the plastic may cause damage to the quality or finish of the projector.

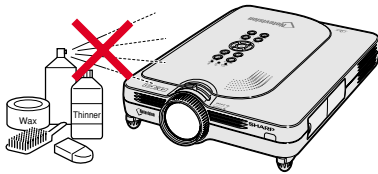

- Wipe off dirt gently with a soft flannel cloth.

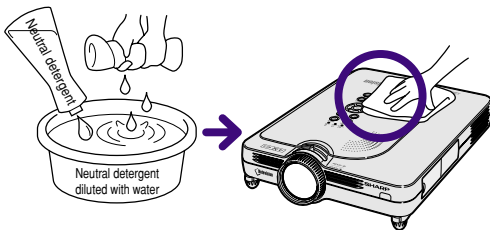

- When the dirt is hard to remove, soak a cloth in a neutral detergent diluted with water, wring the cloth well and then wipe the projector. Strong cleaning detergents may discolor, warp or damage the coating on the projector. Make sure to test on a small, inconspicuous area on the projector before using.

Cleaning the lens

- Use a commercially available blower or lens cleaning paper (for glasses and camera lenses) for cleaning the lens. Do not use any liquid type cleaning agents, as they may wear off the coating film on the surface of the lens.
- As the surface of the lens can easily get damaged, be sure not to scrape or hit the lens.

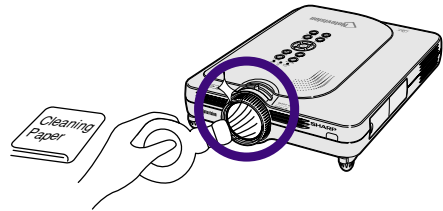

Cleaning the exhaust and intake vents

- Use a vacuum cleaner to clean dust from the exhaust vent and the intake vent.

Projector's Rear View

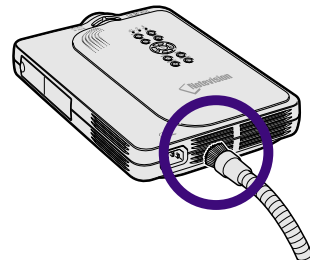

Maintenance Indicators

- The warning lights on the projector indicate problems inside the projector.
- If a problem occurs, either the **TEMPERATURE WARNING** indicator or the **LAMP REPLACEMENT** indicator will illuminate red, and the power will turn off. After the power has been turned off, follow the procedures given below.

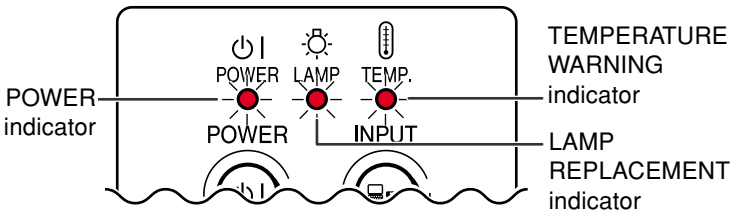

About the TEMPERATURE WARNING indicator

If the temperature inside the projector increases, due to blockage of the air vents, or the setting location, “TEMP.” will blink in the lower left corner of the picture. If the temperature keeps on rising, the lamp will turn off and the TEMPERATURE WARNING indicator will blink, the cooling fan will run for further 90 seconds, then the power will be shut off. After “TEMP.” appears, be sure to perform the following measures.



About the LAMP REPLACEMENT indicator



- When the lamp exceeds 1,900 cumulative hours of use, “LAMP” will be displayed on the screen in yellow. When the cumulative hours of use reach 2,000, “LAMP” will change to red, the lamp will automatically turn off and then the projector as well. At this time, the LAMP REPLACEMENT indicator will illuminate in red.
- If you try to turn on the projector a fourth time without replacing the lamp, the projector will not turn on.

Maintenance indicator		Condition	Problem	Possible Solution
TEMPERATURE WARNING indicator	Normal	The internal temperature is abnormally high.	<ul style="list-style-type: none"> • Blocked air intake • Cooling fan breakdown • Internal circuit failure • Clogged air intake 	<ul style="list-style-type: none"> • Relocate the projector to an area with proper ventilation. • Take the projector to your nearest Sharp Authorized Projector Dealer or Service Center (see page 78) for repair.
	Abnormal			
LAMP REPLACEMENT indicator	Green on Green blinks when the lamp is active.	Red blinks	Time to change the lamp	<ul style="list-style-type: none"> • Take the projector to your nearest Sharp Authorized Projector Dealer or Service Center (see page 78) for repair or lamp replacement. • Please exercise care when replacing the lamp.
		Red on/Power off	The lamp does not illuminate.	

Info

- If the TEMPERATURE WARNING indicator illuminates, and the power turns off, follow the above possible solutions and then wait until the projector has cooled down completely before plugging in the power cord and turning the power back on. (At least 5 minutes.)
- If the power is turned off and then turned on again, as during a brief test, the LAMP REPLACEMENT indicator may be triggered, preventing the power from going on. Should this occur, take the power cord out of the wall outlet and plug it back in again.
- If you want to clean the air vents during projector operation, be sure to first press  and after the power has turned off and the cooling fan has stopped, then clean the vents.
- Do not unplug the power cord after the power has been turned off and while the cooling fan is running. The cooling fan runs for about 90 seconds.

Regarding the Lamp

Lamp

- It is recommended that the lamp (sold separately) be replaced after approximately 1,900 cumulative hours of use or when you notice a significant deterioration of the picture and color quality. The lamp usage time can be checked with the on-screen display. See page 58.
- For lamp replacement, please consult your nearest Sharp Authorized Projector Dealer or Service Center.

IMPORTANT NOTE TO U.S. CUSTOMERS:

The lamp included with this projector is backed by a 90-day parts and labor limited warranty. All service of this projector under warranty, including lamp replacement, must be obtained through a Sharp Authorized Projector Dealer or Service Center. For the name of the nearest Sharp Authorized Projector Dealer or Service Center, please call toll-free: 1-888-GO-SHARP (1-888-467-4277). U.S.A. ONLY

Caution Concerning the Lamp

- This projector utilizes a pressurized mercury lamp. A loud sound may indicate lamp failure. Lamp failure can be attributed to numerous sources such as: excessive shock, improper cooling, surface scratches or deterioration of the lamp due to a lapse of usage time. The period of time up to failure largely varies depending on the individual lamp and/or the condition and the frequency of use. It is important to note that failure can often result in the bulb cracking.
- When the LAMP REPLACEMENT indicator and on-screen display icon are illuminated or flash, it is recommended that the lamp be replaced with a new one immediately, even if the lamp appears to be operating normally.
- Should the lamp break, the glass particles may spread inside the lamp cage or gas contained in the lamp may be vented into the room from the exhaust vent. Because the gas in this lamp includes mercury, ventilate the room well if the lamp breaks and avoid all exposure to the released gas. In case of exposure to the gas, consult with a doctor as soon as possible.
- Should the lamp break, there is also a possibility that glass particles may spread inside of the projector. In such a case, it is recommended you contact your nearest Sharp Authorized Projector Dealer or Service Center to remove the damaged lamp and assure safe operation.

Replacing the Lamp

Caution

- Do not remove the lamp unit immediately after operation of the projector. The lamp will be hot and touching it can lead to burn or injury.
- Wait at least one hour after the power cord is disconnected to allow the surface of the lamp unit to fully cool before removing the lamp unit.
- If the new lamp does not light after replacement, take your projector to the nearest Sharp Authorized Projector Dealer or Service Center for repair. Purchase a replacement lamp unit of type BQC-PGM20X//1 from your nearest Sharp Authorized Projector Dealer or Service Center. Then carefully change the lamp by following the instructions described in this section. If you wish, you may have the lamp replaced at your nearest Sharp Authorized Projector Dealer or Service Center.

Regarding the Lamp (cont.)

Removing and Installing the Lamp Unit

Info

- Be sure to remove the lamp unit by the handle. Be sure not to touch the glass surface of the lamp unit or the inside of the projector.
- To avoid injury to yourself and damage to the lamp, be sure to carefully follow the steps below.
- Do not loosen other screws except for the lamp unit cover and lamp unit.
- Please refer to the installation manual included with the lamp unit.

1 Press on the projector to turn off the power.

- Wait until the cooling fan stops.

2 Disconnect the power cord.

- Unplug the power cord from the AC socket.
- Leave the lamp until it has fully cooled down (about 1 hour).

3 Remove the lamp unit cover.

- Turn over the projector, and loosen the user service screw that secures the lamp unit cover. Then slide the cover in the direction of the arrow.

Lamp unit

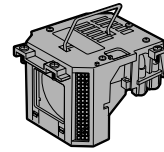

BQC-PGM20X//1

POWER button

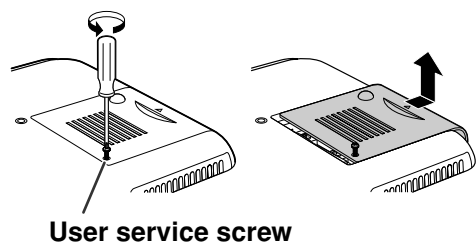
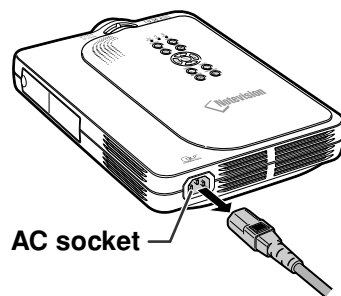
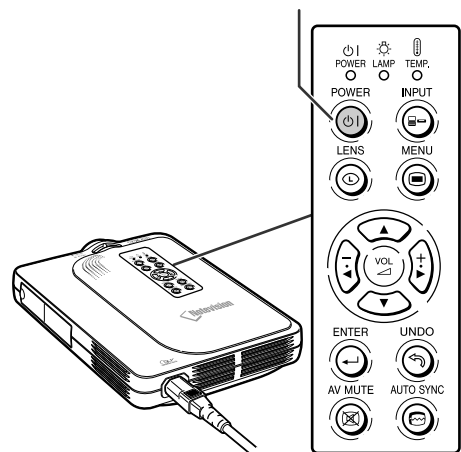

User service screw

4 Remove the lamp unit.

- Loosen the securing screws from the lamp unit. Hold the lamp unit by the handle and pull it in the direction of the arrow.

5 Insert the new lamp unit.

- Press the lamp unit firmly into the lamp unit compartment. Fasten the securing screws.

6 Attach the lamp unit cover.

- Slide the lamp unit cover in the direction of the arrow. Then tighten the user service screw.

Info

- If the lamp unit and lamp cover are not correctly installed, the power will not turn on, even if the power cord is connected to the projector.

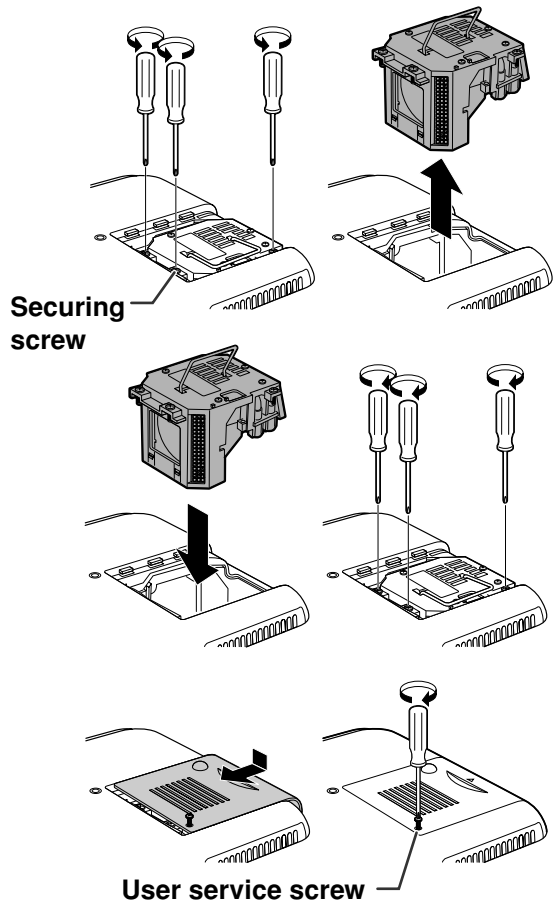

Resetting the Lamp Timer

Reset the lamp timer after replacing the lamp.

1 Connect the power cord.

- Plug the power cord into the AC socket of the projector.

2 Reset the lamp timer.

- While pressing simultaneously



and **ENTER** on the projector, press **POWER** on the projector.

- "LAMP 0000H" is displayed, indicating that the lamp timer is reset.

Info

- Make sure to reset the lamp timer only when replacing the lamp. Otherwise, this may cause the lamp to become damaged or explode.

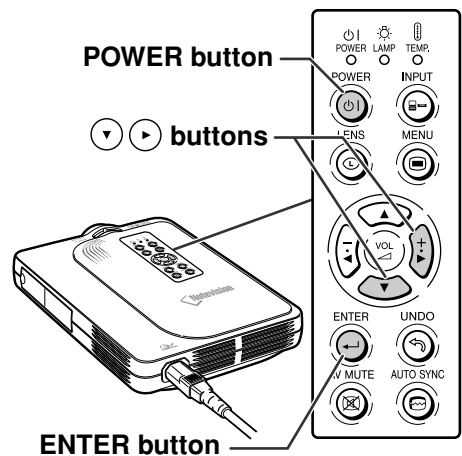
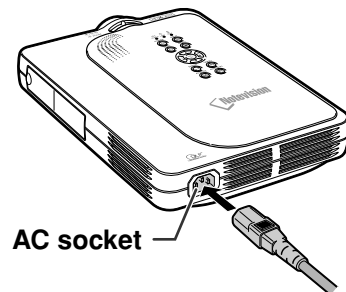

Connecting Pin Assignments

DVI Digital / Analog INPUT 1 terminal : 29 pin connector

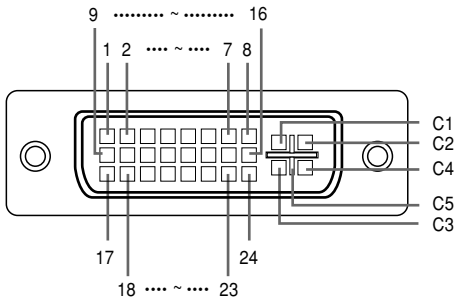

• DVI Digital RGB Input

Pin No.	Signal	Pin No.	Signal
1	T.M.D.S data 2-	16	Hot plug detection
2	T.M.D.S data 2+	17	T.M.D.S data 0-
3	T.M.D.S data 2 shield	18	T.M.D.S data 0+
4	Not connected	19	T.M.D.S data 0 shield
5	Not connected	20	Not connected
6	DDC clock	21	Not connected
7	DDC data	22	T.M.D.S clock shield
8	Not connected	23	T.M.D.S clock+
9	T.M.D.S data 1-	24	T.M.D.S clock-
10	T.M.D.S data 1+	C1	Not connected
11	T.M.D.S data 1 shield	C2	Not connected
12	Not connected	C3	Not connected
13	Not connected	C4	Not connected
14	+5V power	C5	Ground
15	Ground		

• DVI Analog RGB Input

Pin No.	Signal	Pin No.	Signal
1	Not connected	16	Hot plug detection
2	Not connected	17	Not connected
3	Not connected	18	Not connected
4	Not connected	19	Not connected
5	Not connected	20	Not connected
6	DDC clock	21	Not connected
7	DDC data	22	Not connected
8	Vertical sync	23	Not connected
9	Not connected	24	Not connected
10	Not connected	C1	Analog input Red
11	Not connected	C2	Analog input Green
12	Not connected	C3	Analog input Blue
13	Not connected	C4	Horizontal sync
14	+5V power	C5	Ground
15	Ground		

• DVI Analog Component Input

Pin No.	Signal	Pin No.	Signal
1	Not connected	16	Not connected
2	Not connected	17	Not connected
3	Not connected	18	Not connected
4	Not connected	19	Not connected
5	Not connected	20	Not connected
6	Not connected	21	Not connected
7	Not connected	22	Not connected
8	Not connected	23	Not connected
9	Not connected	24	Not connected
10	Not connected	C1	Analog input Pr/Cr
11	Not connected	C2	Analog input Y
12	Not connected	C3	Analog input Pb/Cb
13	Not connected	C4	Not connected
14	Not connected	C5	Ground
15	Ground		

USB port: 4 pin B-type USB connector

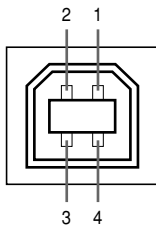

Pin no.	Signal	Name
1	VCC	USB power
2	USB-	USB data-
3	USB+	USB data+
4	SG	Signal Ground

Computer Compatibility Chart

- Multiple signal support
Horizontal Frequency: 15–102 kHz
Vertical Frequency: 43–160 Hz*
Pixel Clock: 12–120 MHz
- Compatible with sync on green and composite sync signals
- SXGA+, SXGA and XGA compatible in advanced intelligent compression
- AICS (Advanced Intelligent Compression and Expansion System) resizing technology

The following is a list of modes that conform to VESA. However, this projector supports other signals that are not VESA standards.

PC/MAC/WS	Resolution	Horizontal Frequency (kHz)	Vertical Frequency (Hz)	VESA Standard	DVI Support	Display	
PC	640 × 350	27.0	60			Upscale	
		31.5	70				
		37.9	85	✓			
		27.0	60				
		31.5	70				
		27.0	60		✓		
	640 × 400	31.5	70		✓		
		37.9	85	✓	✓		
		27.0	60		✓		
		31.5	70		✓		
		37.9	85	✓	✓		
		27.0	60		✓		
	720 × 400	31.5	70		✓		
		37.9	85	✓	✓		
		26.2	50				
		31.5	60		✓		
		34.7	70				
		37.9	72	✓	✓		
	640 × 480	37.5	75	✓	✓		
		43.3	85	✓	✓		
		47.9	90				
		53.0	100				
		61.8	120				
		78.5	150				
		80.9	160				
		31.4	50				
		35.1	56	✓	✓		
		37.9	60	✓	✓		
	SVGA	800 × 600	44.5	70			
			48.1	72	✓		✓
			46.9	75	✓		✓
			53.7	85	✓		✓
			56.8	90			
			64.0	100			
			77.2	120			
			98.3	150			
			102.1	160			
			35.5	43			✓
	XGA	1,024 × 768	40.3	50			
			48.4	60	✓		✓
56.5			70	✓	✓		
58.1			72	✓	✓		
60.0			75	✓	✓		
68.7			85	✓	✓		
73.5			90				
77.2			96				
80.6			100				





PC/MAC/WS	Resolution	Horizontal Frequency (kHz)	Vertical Frequency (Hz)	VESA Standard	DVI Support	Display	
PC	SXGA	1,152 × 864	54.3	60		✓	
			64.0	70			
			64.1	72			
			67.5	75	✓	✓	
			75.7	80			
		1,152 × 882	54.8	60			
			65.9	72			
			67.4	74			
			1,280 × 1,024	64.0	60	✓	✓
			SXGA+	1,400 × 1,050	64.0	60	
PC/MAC 13"	VGA	640 × 480	34.9	67		Upscale	
PC/MAC 19"	XGA	1,024 × 768	48.4	60	✓	✓	
			60.0	75	✓	✓	
MAC 16"	SVGA	800 × 600	46.8	75			
			832 × 624	49.6	75		True
MAC 21"	SXGA	1,152 × 870	68.5	75			
PC (WS)	SXGA	1,280 × 960	60.0	60	✓		
SGL (WS)			1,280 × 1,024	53.5	50		
SUN (WS)			1,152 × 900	60.9	66		
			71.9	76		Advanced Intelligent Compression	

* Temporary noise may be visible with vertical frequencies above 100Hz if OSD functions are activated.

Note

- This projector may not be able to display images from notebook computers in simultaneous (CRT/LCD) mode. Should this occur, turn off the LCD display on the notebook computer and output the display data in "CRT only" mode. Details on how to change display modes can be found in your notebook computer's operation manual.
- When this projector receives 640 × 350 VESA format VGA signals, "640 × 400" appears on the screen.

Troubleshooting

Problem	Check	Page
 <p>No picture and no sound or projector does not start.</p>	<ul style="list-style-type: none"> • Projector power cord is not plugged into the wall outlet. 	20
	<ul style="list-style-type: none"> • Power to the external connected devices is off. 	—
	<ul style="list-style-type: none"> • The selected input mode is wrong. 	29
	<ul style="list-style-type: none"> • Cables incorrectly connected to side panel of the projector. 	21–26
	<ul style="list-style-type: none"> • Remote control batteries have run out. 	13
	<ul style="list-style-type: none"> • External output has not been set when connecting notebook computer. • The AV MUTE display appears. 	— 30
	<ul style="list-style-type: none"> • The lamp unit and the lamp unit cover are not installed correctly. 	72
 <p>Sound is heard but no picture appears</p>	<ul style="list-style-type: none"> • Cables incorrectly connected to the side panel of the projector. 	21–26
	<ul style="list-style-type: none"> • “Bright” is set to minimum position. 	40
 <p>Color is faded or poor</p>	<ul style="list-style-type: none"> • Picture adjustments are incorrectly set. 	40
	(Video Input only) <ul style="list-style-type: none"> • Video input system is incorrectly set. 	55
	(INPUT 1 only) <ul style="list-style-type: none"> • Input signal type RGB/Component is incorrectly set. 	40
 <p>Picture is blurred; noise appears</p>	<ul style="list-style-type: none"> • Adjust the focus. 	31
	<ul style="list-style-type: none"> • The projection distance exceeds the focus range. 	17–18
	(Computer Input only) <ul style="list-style-type: none"> • Perform “Fine Sync” Adjustments (“Clock” Adjustment) • Perform “Fine Sync” Adjustments (“Phase” Adjustment) • Noise will appear depending on the computer. 	42·44 42 —
	<ul style="list-style-type: none"> • The “DNR” (Digital Noise Reduction) setting is not correct. 	54
 <p>Picture appears but no sound is heard</p>	<ul style="list-style-type: none"> • Cables incorrectly connected to side panel of projector. 	21–26
	<ul style="list-style-type: none"> • Volume is set to minimum. 	29
<p>An unusual sound is occasionally heard from the cabinet</p>	<ul style="list-style-type: none"> • If the picture is normal, the sound is due to cabinet shrinkage caused by a room temperature changes. This will not affect operation or performance. 	—
<p>Maintenance indicator illuminates</p>	<ul style="list-style-type: none"> • See “Maintenance Indicators”. 	70
<p>Image cannot be captured</p>	<ul style="list-style-type: none"> • The signal in INPUT 1 is not an analog RGB/Digital RGB SVGA (800 × 600) signal. Images cannot be captured if the signals are different from the above. 	56
<p>Pict in Pict does not work</p>	<ul style="list-style-type: none"> • The signal in INPUT 1 is set to a resolution that exceeds SXGA. • The signal in INPUT 1 is sending Component signals 480I, 480P, 720P, or 1080I. • The signal in INPUT 1 is set to interlace mode using RGB signals. 	51

Problem	Check	Page
Power cannot be turned on or off using the POWER button on the projector	<ul style="list-style-type: none"> The Keylock level is set. If the Keylock level is set to Level B, all the buttons are locked. If the Keylock level is set to Level A, only the INPUT, VOLUME and AV MUTE buttons work. 	60
Picture is green on INPUT 1 COMPONENT Picture is pink (no green) on INPUT 1 RGB	<ul style="list-style-type: none"> Change the input signal type setting. 	40
Picture is dark	<ul style="list-style-type: none"> The LAMP REPLACEMENT indicator is blinking in red. Replace the lamp. 	72-73
	<ul style="list-style-type: none"> “Monitor Out” is set to “Disable” when the RGB monitor loop-out adaptor is connected to Monitor Out. 	58
Picture is too bright and whitish	<ul style="list-style-type: none"> “Monitor Out” is set to “Yes (Y Cable)” when the RGB monitor loop-out adaptor is not connected to Monitor Out. 	58
	<ul style="list-style-type: none"> Picture adjustments are incorrectly set. 	40
The VOLUME buttons on the projector do not work	<p>The VOLUME buttons do not work when: (try the VOL+/- on the remote control)</p> <ul style="list-style-type: none"> when the menu is displayed when the lens menu is displayed when Pict in Pict is working during Enlarge (More than double size) a dot by dot screen resolution larger the panel resolution. 	—

For SHARP Assistance

If you encounter any problems during setup or operation of this projector, first refer to the “Troubleshooting” section on pages 76 and 77. If this operation manual does not answer your question, please contact the SHARP Service departments listed below.

U.S.A.	Sharp Electronics Corporation 1-888-GO-SHARP (1-888-467-4277) lcdsupport@sharpsec.com http://www.sharplcd.com	Austria	Sharp Electronics Austria (Ges.m.b.H.) 0043 1 727 19 123 pogats@sea.sharp-eu.com http://www.sharp.at
Canada	Sharp Electronics of Canada Ltd. (905) 568-7140 http://www.sharp.ca	Australia	Sharp Corporation of Australia Pty. Ltd. 1300-135-022 http://www.sharp.net.au
Mexico	Sharp Electronics Corporation Mexico Branch (525) 716-9000 http://www.sharp.com.mx	New Zealand	Sharp Corporation of New Zealand (09) 634-2059, (09) 636-6972 http://www.sharpnz.co.nz
Latin America	Sharp Electronics Corp. Latin American Group (305) 264-2277 www.servicio@sharpsec.com http://www.siemprisharp.com	Singapore	Sharp-Roxy Sales (S) Pte. Ltd. 65-226-6556 ckng@srs.global.sharp.co.jp http://www.sharp.com.sg
Germany	Sharp Electronics (Europe) GMBH 01805-234675 http://www.sharp.de	Hong Kong	Sharp-Roxy (HK) Ltd. (852) 2410-2623 dcmktg@srh.global.sharp.co.jp http://www.sharp.com.hk
U.K.	Sharp Electronics (U.K.) Ltd. 0161-205-2333 custinfo@sharp-uk.co.uk http://www.sharp.co.uk	Malaysia	Sharp-Roxy Sales & Service Co. (60) 3-5125678
Italy	Sharp Electronics (Italy) S.P.A. (39) 02-89595-1 http://www.sharp.it	U.A.E.	Sharp Middle East Fze 971-4-81-5311 helpdesk@smef.global.sharp.co.jp
France	Sharp Electronics France 01 49 90 35 40 hotlinecd@sef.sharp-eu.com http://www.sharp.fr	Thailand	Sharp Thebnakorn Co. Ltd. 02-236-0170 svc@stcl.global.sharp.co.jp http://www.sharp-th.com
Spain	Sharp Electronica Espana, S.A. 93 5819700 sharplcd@sees.sharp-eu.com http://www.sharp.es	Korea	Sharp Electronics Incorporated of Korea (82) 2-3660-2002 webmaster@sharp-korea.co.kr http://www.sharp-korea.co.kr
Switzerland	Sharp Electronics (Schweiz) AG 0041 1 846 63 11 cattaneo@sez.sharp-eu.com http://www.sharp.ch	India	Sharp Business Systems (India) Limited (91) 11- 6431313 service@sharp-oa.com
Sweden	Sharp Electronics (Nordic) AB (46) 8 6343600 vision.support@sen.sharp-eu.com http://www.sharp.se		

Specifications

Product type	Digital Multimedia Projector
Model	PG-M20S
Video system	NTSC 3.58/NTSC 4.43/PAL/PAL-M/PAL-N/PAL 60/SECAM/ DTV480I/DTV480P/DTV720P/DTV1080I
Display method	Single Chip Digital Micromirror Device™ (DMD™) by Texas Instruments
DMD panel	Panel size: 0.55" (14 mm), 1 chip SVGA DMD No. of dots: 480,000 dots (800 [H] × 600 [V])
Lens	1–1.2 × zoom lens, F1.75–2.04, f = 28.0–33.5 mm
Projection lamp	High Intensity Discharge Lamp (HID Lamp), DC 210 W
Component input signal	29-pin connector
(INPUT1)	DVI input signal: Digital 250–1,000 mV 50 Ω Analog 0.7 Vp-p 75 Ω Y: 1.0 Vp-p, sync negative, 75 Ω terminated P _B : 0.7 Vp-p, 75 Ω terminated P _R : 0.7 Vp-p, 75 Ω terminated
Horizontal resolution	500 TV lines (S-VIDEO)
Computer RGB input signal	29-pin connector
(INPUT 1)	RGB separate/sync on green type analog input: 0–0.7 Vp-p, positive, 75 Ω terminated HORIZONTAL SYNC. SIGNAL: TTL level (positive/negative) VERTICAL SYNC. SIGNAL: Same as above
S-video input signal	4-pin Mini DIN connector
(INPUT 2)	Y (luminance signal): 1.0 Vp-p, sync negative, 75 Ω terminated C (chrominance signal): Burst 0.286 Vp-p, 75 Ω terminated
Video input signal	RCA connector: VIDEO, composite video, 1.0 Vp-p, sync negative, 75 Ω
(INPUT 3)	terminated
Pixel clock	12–120 MHz
Vertical frequency	43–160 Hz*
Horizontal frequency	15–102 kHz
Audio input signal	ø3.5 mm MINIJACK: AUDIO, 0.5 V _{rms} , more than 47 kΩ (stereo)
Audio output	2.0 W (monaural)
Speaker system	4 cm × 3 cm
Rated voltage	AC 100–240 V
Input current	3.2 A
Rated frequency	50/60 Hz
Power consumption	290 W
Heat dissipation	1,090 BTU/hour
Operating temperature	41°F to 95°F (+5°C to +35°C)
Storage temperature	–4°F to 140°F (–20°C to +60°C)
Cabinet	Plastic
I/R carrier frequency	38 kHz
Dimensions (approx.)	8 5/8" × 3" × 11 15/16" (219 (W) × 76 (H) × 303 (D) mm) (main body only) 8 3/4" × 3 1/4" × 12 1/2" (223 (W) × 83 (H) × 318 (D) mm) (including adjustment feet and projecting parts)
Weight (approx.)	5.8 lbs. (2.6 kg)
Supplied accessories	Remote control, Two R-03 batteries, Power cord for U.S., Canada etc. (6', 1.8 m), Power cord for Europe, except U.K. (6', 1.8 m), Power cord for U.K., Hong Kong and Singapore (6', 1.8 m), Power cord for Australia, New Zealand and Oceania (6', 1.8 m), DVI to 15-pin D-sub cable (6', 1.8 m), USB cable (6', 1.8 m), Carrying case, Lens cap (attached), Lens cap strap, Terminal cover (attached), CD-ROM, Operation manual, Quick reference guides
Replacement parts	Lamp unit (Lamp/cage module) (BQC-PGM20X//1), Remote control (RRMCGA013WJSA), Two R-03 batteries ("AAA" size, UM/SUM-4, HP-16, or similar), Power cord for U.S., Canada etc. (QACCCA007WJPZ), Power cord for Europe, except U.K. (QACCV4002CEZZ), Power cord for U.K., Hong Kong and Singapore (QACCA012WJPZ), Power cord for Australia, New Zealand and Oceania (QACCL3022CEZZ), DVI to 15-pin D-sub cable (QCNWGA010WJZZ), USB cable (QCNWG0001WJPZ), Carrying case (GCASN0005CESA), Lens cap (CCAPHA001WJ01), Lens cap strap (UBNDT0013CEZZ), Terminal cover (GCOVD0103CESA), CD-ROM (UDSKAA009WJZZ), Operation manual (TINS-A209WJZZ), Quick reference guides

* Temporary noise may be visible with vertical frequencies above 100Hz if OSD functions are activated.

This SHARP projector uses a DMD panel. This very sophisticated panel contains 480,000 pixels. As with any high technology electronic equipment such as large screen TVs, video systems and video cameras, there are certain acceptable tolerances that the equipment must conform to.

This unit has some inactive pixels within acceptable tolerances which may result in inactive dots on the picture screen. This will not affect the picture quality or the life expectancy of the unit.

Specifications are subject to change without notice.

Dimensions

Units: inches (mm)

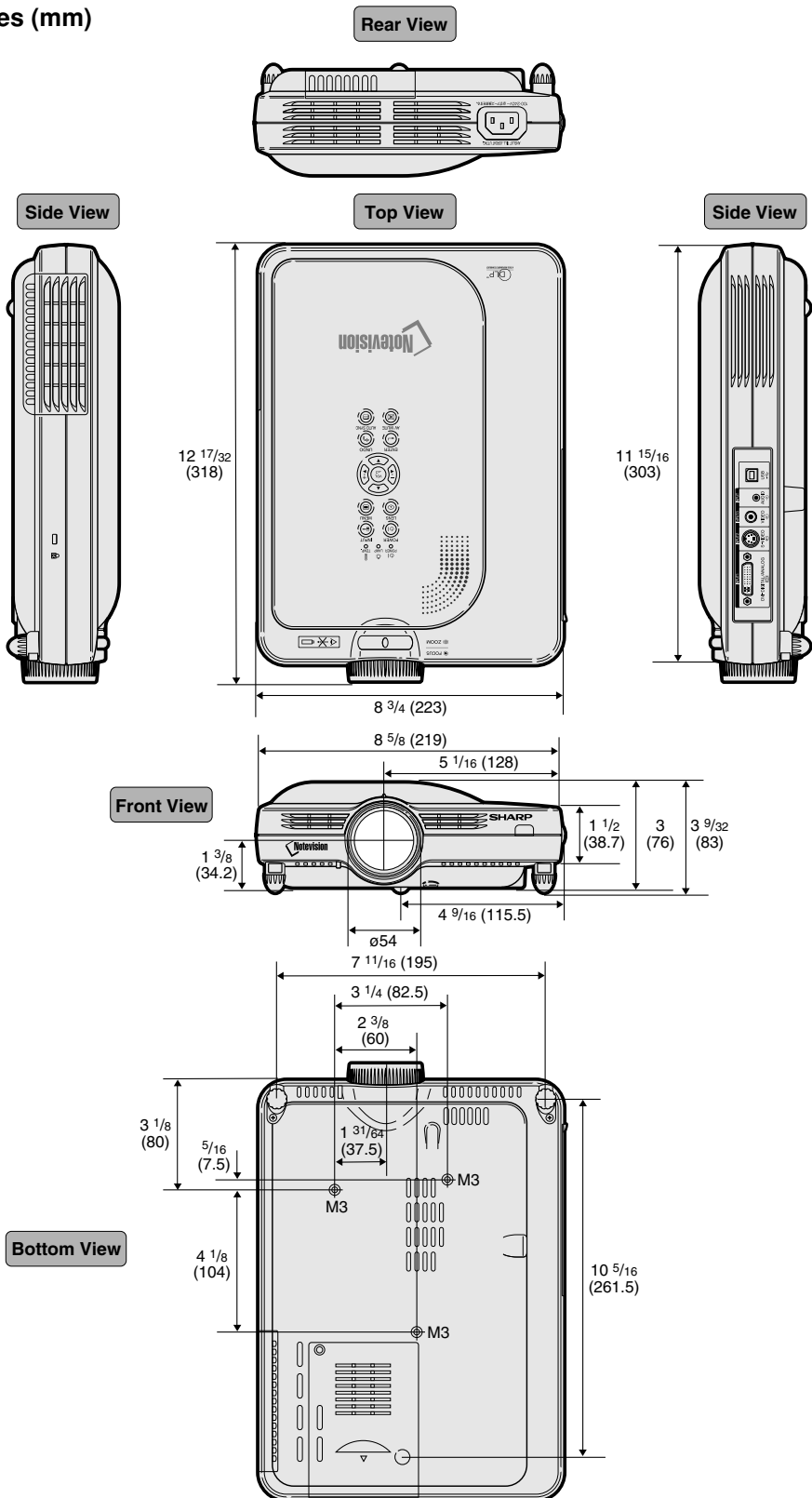

Advanced intelligent compression

High quality resizing of lower and higher resolution images to fit the projector's native resolution.

Anti-theft

In case the projector is stolen, this function disables projection of images if the correct keycode is not entered.

Aspect Ratio

Width and height ratio of an image. The normal aspect ratio of a computer and video image is 4:3. There are also wide images with an aspect ratio of 16:9 and 21:9.

Auto Sync

Optimizes projected computer images by automatically adjusting certain characteristics.

Background

Initial setting image projected when no signal is being output.

Border

Projects a 4:3 image fully within a 16:9 screen by keeping the aspect ratio at 4:3.



Clock

Clock adjustment is used to adjust vertical noise when clock level is incorrect.

CLR Temp (Color temperature)

Function that can be used to adjust the color temperature to suit the type of image input to the projector. Decrease the color temperature to create warmer, reddish images for natural flesh tones, or increase to create cooler, bluish images for a brighter picture.

Digital Shift

Shifts image up or down easily by ,  buttons when RESIZE mode of input image is BORDER, STRETCH or SMART STRETCH of the video or the DTV signals.

Dot by dot

Mode that projects images in their native resolution.

DVI (Digital Visual Interface)

Display digital interface that also supports Analog interfaces.

Freeze

Temporarily freezes a moving image.

GAMMA

Image quality enhancement function that offers a richer image by brightening the darker portions of the image without altering the brightness of the brighter portions. You can select four different modes: STANDARD, PRESENTATION, CINEMA and GAME.

Keylock Level

Mode that can lock the operation of projector buttons to prevent mischief.

Keystone correction

Function to digitally correct a distorted image when the projector is set up at an angle, smoothens out jaggies on keystone images and compresses the image not only horizontally but vertically keeping the 4:3 aspect ratio.

Password

A password is set so that changes cannot be made in the settings of the "Options (2)" menu.

Phase

Phase shift is a timing shift between isomorphic signals with the same resolution. When phase level is incorrect, the projected image typically displays horizontal flicker.

Picture in Picture

Allows you to add video images onto a data screen image, providing you with even more effective presentations.

Progressive Mode

The progressive display projects a smoother video image. You can select three different modes: 2D Progressive, 3D Progressive and Film Mode.

RESIZE

Allows you to modify or customize the picture display mode to enhance the input image. You can select six different modes: NORMAL, FULL, DOT BY DOT, BORDER, STRETCH and SMART STRETCH.

Smart Stretch

Projects the image fully in a 16:9 screen by enlarging only the surrounding areas while keeping the aspect ratio in the middle part of the image at 4:3.

sRGB

An international standard of color reproduction regulated by the IEC (International Electrotechnical Commission). As the fixed color area has been decided by the IEC, the color changes according to DLP features, so that the images are displayed in a natural tint based on an original image, when switching to the "sRGB" mode.

Startup Image

The image displayed when the projector is turned on.

Status function

Displays the settings of each adjustment item.

Stretch

Mode that stretches the 4:3 image horizontally to display it fully on a 16:9 screen.

Index

2D Progressive	41	Lens adjustment	31
3D Progressive	41	LENS button	32
AC socket	20	Lens cap	68
Adjustment buttons	36	Lens cap strap	11
Adjustment feet	16	MENU button	36
All Reset	65	Monitor Out	58
Anti-Theft	63	NORMAL	47
Aspect ratio	47	Optional accessories	14
Auto Power Off	52	OSD Display (On-screen display)	54
Auto Search	53	Password	61
Auto Sync adjustment	44	PDF	9
AUTO SYNC button	44	Phase	42
Auto Sync Display	44	Pict in Pict	51
AV MUTE button	30	Picture adjustments	40
BACK button	26	POWER button	28
Background image	57	Power cord	20
Batteries	13	POWER indicator	28
BORDER	47	Power Save Mode	52
Carrying case	68	PRJ mode	60
Ceiling-mount	19	Progressive Mode	41
Clock	42	Remote control	12
CLR Temp (Color Temperature)	40	Remote control sensor	13
Component input	23	Remote control signal transmitter	12
Computer images adjustment	42	Replacing the lamp	71
Digital Shift	33	RESIZE button	46
DNR	54	Reversing/Inverting Images	60
DOT BY DOT	47	Save Setting	42
DVI to 15-pin D-sub cable	21	Select Setting	43
ENLARGE buttons	49	Signal Info	43
ENTER button	36	Signal Type	40
Exhaust vent	69	SMART STRETCH	47
Film Mode	41	Speaker	29
Fine Sync	42	Special Mode adjustment	43
Focus ring	31	sRGB	53
Foot releases	16	Startup image	57
FORWARD button	26	Status	66
FREEZE button	48	STRETCH	47
FULL	47	Supplied accessories	14
GAMMA button	50	TEMPERATURE WARNING indicator	70
Image Capture	56	Terminal cover	10
INPUT 1 terminal	21	UNDO button	33
INPUT 1 – 3 modes	29	USB cable	26
INPUT 2 terminal	24	USB port	26
INPUT 3 terminal	24	Video System	55
INPUT AUDIO terminal	21	VOLUME buttons	29
INPUT button	29	Wireless Presentation	26
Intake vent	69	Zoom knob	31
Kensington Security Standard connector	11		
Keylock level	60		
Keystone correction (adjustment)	32		
Lamp	71		
LAMP REPLACEMENT indicator	70		
Lamp Timer	58		
Language selection	30		

SHARP®
SHARP CORPORATION